

Apple III



Owner's Guide

Desk Bery



Notice

Apple Computer reserves the right to make improvements in the product described in this manual at any time and without notice.

Disclaimer of All Warranties And Liabilities

Apple Computer makes no warranties, either express or implied, with respect to this manual or with respect to the software described in this manual, its quality, performance, merchantability, or fitness for any particular purpose. Apple Computer software is sold or licensed "as is." The entire risk as to its quality and performance is with the buyer. Should the programs prove defective following their purchase, the buyer (and not Apple Computer, its distributor, or its retailer) assumes the entire cost of all necessary servicing, repair, or correction and any incidental or consequential damages. In no event will Apple Computer be liable for direct, indirect, incidental, or consequential damages resulting from any defect in the software, even if Apple Computer has been advised of the possibility of such damages. Some states do not allow the exclusion or limitation of implied warranties or liability for incidental or consequential damages, so the above limitation or exclusion may not apply to you.

This manual is copyrighted. All rights are reserved. This document may not, in whole or part, be copied, photocopied, reproduced, translated or reduced to any electronic medium or machine readable form without prior consent, in writing, from Apple Computer.

© 1981 by Apple Computer
10260 Bandley Drive
Cupertino, California 95014
(408) 996-1010

1 800 776 2333

The word Apple and the Apple logo are registered trademarks of Apple Computer.

Reorder Apple Product #A3L0001

Apple III

Owner's Guide

Contents

Preface

vii

- i Getting Started
- ii Symbols and Labels

1 First Steps

1

- 1 Unpacking
- 1 Plugging In
 - 2 The Power Cord
- 3 Connecting the Monitor
- 3 Handling Diskettes
 - 4 Inserting and Removing Diskettes
- 6 Starting Up
- 7 The Apple III Demonstration Diskette
- 8 Turning It Off
- 9 Installing Disk Drives

2 Using Your Apple III

11

- 11 Standard Procedures
- 11 The Usual Startup Procedure
- 12 Boot Diskettes
- 13 Turnkey Systems
- 14 Using the Console
 - 16 The Keyboard
- 20 Correcting Errors
 - 23 Wrapping and Scrolling
- 25 Leaving the Demonstration

3 ***The Operating System*** **27**

- 27 About SOS
- 27 A Disk-Based System
- 27 Devices
 - 28 Character Devices
 - 28 Block Devices
 - 29 Device Names
- 30 Files
 - 30 Where to Find Files
 - 31 Directory Files
 - 31 Local Names
 - 32 Subdirectories and Pathnames
- 33 An Example: Widgets Incorporated
 - 35 Using Pathnames
 - 37 The Prefix and Partial Pathnames
- 38 Using Files

4 ***The Utilities Diskette*** **41**

- 42 Backing Up the Utilities Diskette
 - 44 Write-Protection
 - 45 Copying with Two Drives
 - 46 Copying with One Drive
- 48 Configuring your System
 - 50 Using the System Configuration Program
 - 52 Changing the System Parameters
 - 53 Generating a New System
- 56 The SOS Diskette Request
- 57 Formatting Blank Diskettes

5 The Filer

63

- 64 Reading a Directory
- 64 Using the Filer
- 69 Operations on Files
 - 70 List files
 - 73 Copy files
 - 76 Delete files
 - 77 Rename files
 - 79 Make a subdirectory
 - 80 set Write protection
 - 81 set Prefix
- 84 Operations on Devices
 - 85 Copy one volume onto another
 - 88 Rename a volume
 - 88 Format a volume
 - 90 Verify a volume
 - 91 List devices configured into system
 - 92 set Time and date
- 93 Utilities Diskette Selection and Editing
 - 93 Menu Selection
 - 93 Editing Input Fields
 - 94 Pathname Selection
 - 96 Summary of Editing Features
 - 97 Summary of Pathname-Selection Keys

6 The Machine

99

- 99 The Front
 - 99 The Keyboard
- 100 The Disk Drive
- 101 Installing External Devices
- 102 The Back
 - 103 The Power Switch and Connector
 - 103 The Disk Drive Connector
 - 104 The Joystick Ports
 - 104 The Silentype Printer Port

104	The Color Video Port
105	The B/W Video Port
105	The Audio Port
105	The Serial Port
106	Inside the Apple III
106	Removing the Cover
107	Peripheral Device Cards
109	Removing Peripheral Cards
110	Installing Peripheral Cards
111	The Speaker
111	The Security Mount
112	Replacing the Cover
112	The Bottom

Appendices

A Error Messages 113

113	Errors During Startup
113	Diagnostic Messages
114	SOS Errors
116	SCP Errors
116	Errors in Reading Driver Files
116	Errors in Editing System Parameters
116	Errors While Generating System
117	Filer Errors
121	General Errors

B Care and Handling 123

123	Care of the Apple III
124	Care of Diskettes

C *Input/Output Port Specifications* 127

- 128 Port A: Joystick Input
- 129 Port B: Joystick Input
- 131 Port C: RS-232-C Serial Interface
- 132 The Color Video Port
- 135 The B/W Video Port
- 135 The Audio Port

D *The Apple II Emulation Diskette* 137

- 138 Using Applesoft
- 139 The Emulation Options
- 141 Limitations
 - 141 Software
 - 142 Peripherals
 - 142 Game Inputs
 - 144 Video
 - 144 Firmware and Hardware
 - 144 Keyboard
 - 145 A Word of Advice

E *System Specifications* 147

- 147 Operating System
- 153 Hardware

Glossary 155

Index 165

Preface

Getting Started

This Owner's Guide is the first book you should read after getting your new Apple III. This Guide has three functions. First, it introduces you to your Apple III: how to unpack it, set it up, and start it working. Second, it shows you some fundamental operating procedures to follow whenever you use your Apple. Third, it tells you about the structure and operation of the Apple and its operating system.

You should read the first chapter as you unpack your Apple. It not only tells you how to unpack, set up, and start up your Apple but it also contains important information about the care and handling of your computer.

The second chapter leads you through the standard procedures you will follow whenever you use your Apple. Here you will learn about all the ways you can control the Apple from the keyboard. The information in this chapter is important and helpful: you should read this chapter carefully and attempt all the examples it contains.

The third chapter describes the Apple's operating system, which is the means of communication between you and the machine. This chapter introduces the concepts of devices, files, and pathnames.

The fourth chapter describes some standard programs that are supplied with your Apple III. The chapter tells you how to back up and format diskettes, and how to set up your copy of the operating system to fit the hardware you have.

The fifth chapter describes the Filer. This program gives you access to the operating system, and lets you use and move the information you have stored on your diskettes.

The sixth chapter describes the parts that make up the machine itself. If you're interested in the capabilities of the built-in devices of your Apple III or in how to install external devices, this chapter will provide the information you need.

At the end of this Guide are several appendices that contain important information. There's also a Glossary that explains any terms that may be unfamiliar to you, and an Index to help you find things.

If your dealer has not already done so, please take a few minutes to complete your Apple III Warranty Registration card and drop it in the mail. This will ensure that you receive the newsletters and other information frequently mailed to Apple owners.

Symbols and Labels

Occasionally in this Guide you will see an indented paragraph with the symbol



This means the indented paragraph contains information that will give you a helping hand.



This informs you that you should be alert: the indented paragraph describes a potential hazard to which you should be alert.



Read carefully—the indented paragraph warns you of a dangerous situation in which you could lose some data you've stored, or possibly damage your Apple III.

First Steps

Unpacking

Your Apple III is packed in a large cardboard shipping carton. This manual was packed in a small shipping carton attached to the Apple III's carton. Enclosed with each carton is a packing list; make sure that each carton you received contains everything named on its list.

The envelope containing the packing list for the Apple III's carton also contains instructions on how to unpack your computer. Save the packing materials in case you wish to transport your Apple III, or must return it to your dealer or the factory for service.

To use your Apple III, you need the contents of the Apple III's carton, the contents of the box in which this manual was packed, and a video display. If you are using a video display other than the Apple III's recommended black-and-white video monitor, ask your Apple dealer to assist you in connecting your monitor to your Apple III.

Plugging In

Almost everything you connect to your Apple III plugs directly into the back of the computer. Place the Apple III on a flat surface and turn it around so that the back is facing you.

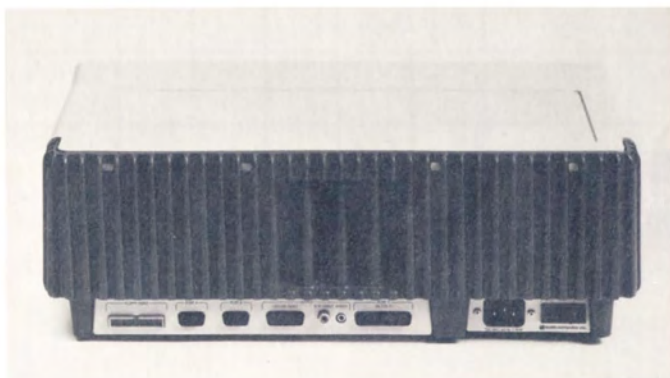

The Back of the Apple III

Now find the power cord and the video cable, which are included in the Apple III's carton. These are the only two things you need to connect to the Apple III at this time. If you have purchased any peripheral devices for your Apple III (such as additional disk drives), please wait until you finish this chapter before you install them.

The Power Cord

The power cord plugs into the right side of the back of the Apple III. The power switch is right next to the power plug. It has two positions: to the left (marked "0", zero) is OFF and to the right (marked "1") is ON. Make sure the power switch is OFF before you plug in the power cord. Plug the other end of the power cord into a standard three-prong grounded wall outlet.



For your own safety, and to protect the Apple III against static charges, you should always make sure that your Apple III is grounded. If you cannot connect your Apple III to a three-prong grounded wall outlet, then use a three-prong to two-prong adaptor, making sure to connect the ground wire on the adaptor to a mounting screw on the wall outlet. If you must use an extension cord to plug in your Apple III, make sure it is a three-wire grounded cord.

Connecting the Monitor

Attach one end of the video cable to the connector marked B/W VIDEO on the back of the Apple III. Attach the other end of the connector to the video monitor, to the jack marked VIDEO IN. Make sure all connectors fit firmly. After you connect the video cable, plug the monitor's power cord into a wall outlet.

If you are using a monitor or television other than the black-and-white video monitor recommended by Apple, please see your dealer for assistance in connecting it to your Apple III.



The video cable is tightly coiled for shipping purposes. Sometimes the coils in the cable set up a magnetic field that kills the video signal before it can get to your monitor. Be sure to uncoil and straighten your video cable before connecting it.

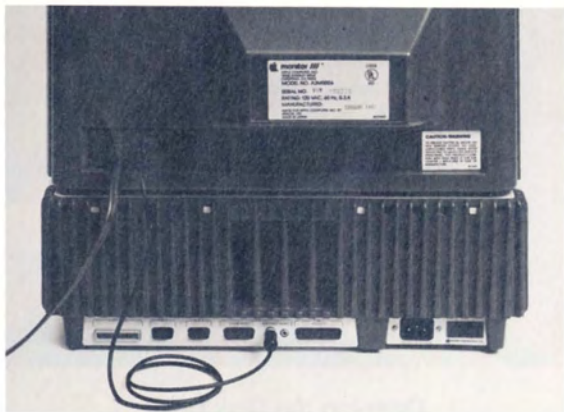

Connecting the Monitor

Handling Diskettes

Now you're ready to start using your Apple III. Most of the programs you will use are stored on *diskettes*. These are coated plastic disks on which the Apple III can store information and read it back later. The

Apple III records information on the surface of a diskette in much the same way as a tape recorder records music on a magnetic tape.

Each diskette is protected by a square black covering, about five inches on a side. This covering is sealed shut and should never be opened. The Apple III reads and writes information on the diskette through the oval slots in the covering. **YOU SHOULD NEVER TOUCH THE SURFACE OF THE DISKETTE ITSELF**; handle it only by its black protective covering. For more information on the use and care of diskettes, see Appendix B.

Inserting and Removing Diskettes

The disk drive is above the keyboard on the right side of the face of the Apple III. Remove the protective tape from the door to the disk drive, then open the door by pulling out on the door's bottom edge.



Opening the Disk Drive

Diskettes are included in the box that contained this manual. Find the diskette labeled **APPLE III DEMONSTRATION DISKETTE** and slide it out of its paper sleeve. Hold it in your right hand, between your thumb and forefinger, with the label upwards.

A Good RULE OF THUMB:

Hold a diskette with the label on top, your right thumb on the label, and the oval slot pointing at the drive.

This is the correct orientation for inserting the diskette into the disk drive.

Insert the far edge of the diskette (the edge with the oval cutout) into the slot in the disk drive. The label should enter the drive last. Push the diskette in until it is entirely inside the drive. Push gently; if you bend the diskette, you may damage it permanently. If the diskette does not go in smoothly, pull it out and try again, wiggling it if necessary.



Inserting a Diskette

Close the disk drive door by pushing it down gently until it clicks into place. If you can't close the door, the diskette isn't all the way in; try removing the diskette and inserting it again.

When you want to remove a diskette from the drive, open it and pull the diskette out (and a little upward) without bending it, and put it back into its protective paper sleeve.

Starting Up

Now that the diskette is in the drive, you're ready to go. First turn on your video monitor. Now reach behind the Apple III and turn the power switch ON. Immediately the "ON" light on the keyboard will light up, the screen will flash briefly, and the red light under the door of the disk drive will come on. The "ON" light tells you that your Apple III is on and running; the red light on the disk drive tells you that it is using the diskette.



You should not open the drive door, remove a diskette, or turn the Apple III's power off while the disk drive's red light is on. Doing so might interrupt the Apple III while it is writing on the diskette, causing some of the data to be unusable.

The screen should display something like this:



Demonstration Diskette
Startup Screen



If the screen shows the word **RETRY** in the upper left-hand corner, make sure you've inserted the diskette correctly, then hold down the key marked **CONTROL** on the left side of the keyboard and at the same time press and release the flat button marked **RESET** on the back of the right side of the keyboard. Now release the **CONTROL** key. If **RETRY** appears again, or if the word **DIAGNOSTIC** appeared in the upper left-hand corner, something is wrong with your Apple III: see Appendix A for instructions. If you get a similar message at any other time, see Appendix A.

If you have a Monitor III, use the vertical-hold and vertical-size controls to stabilize the picture in the middle of the screen; adjust the brightness and contrast controls on your monitor so that the image is clear and sharp. The contrast control is on the front of the monitor; the others are on the back.

If you have a Sanyo monitor, use the horizontal-hold and vertical-hold controls to stabilize the picture in the middle of the screen; adjust the brightness and contrast controls on your monitor so that the image is clear and sharp.

The Apple III Demonstration Diskette

The Demonstration diskette contains programs that demonstrate some features and capabilities of your Apple III. If you have been following our instructions, some demonstrations are now performing on your monitor's screen. The demonstrations are a continuous cycle; once you have started the programs, they will repeat until you stop them or turn off the Apple III.

There are other demonstration programs on the diskette that are not part of the main cycle. These programs are *interactive*; they need you to control their operation. To use these interactive programs, press the key marked **ESCAPE** in the upper-left corner of the keyboard. The main demonstrations will immediately cease and the screen will show a display similar to this:

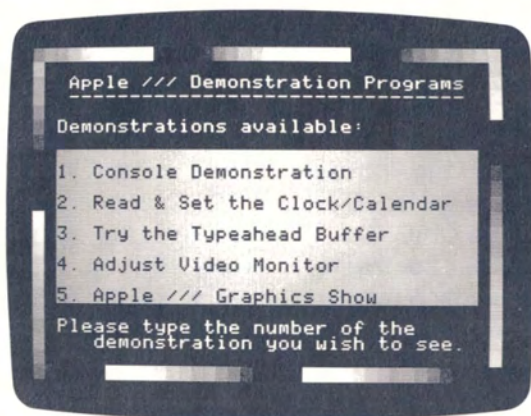

Demonstration Menu

This list of numbered descriptions is called a *menu*. It works like a breakfast menu at a cafe. If you want scrambled eggs with hash brown potatoes you can just say, "I'll have a number 5". If you want to see demonstration number 1, you tell the Apple III that you want it by pressing either key marked "1".

Each of the demonstration programs contains instructions on what it does and how you use it. Some of the demonstrations are referred to in the next chapter, but you can experiment with them now. When you want to leave a demonstration and go back to the main menu, press the ESCAPE key.

Turning It Off

The Apple III, like many other electronic devices, warms up when you leave it on, and works better if it stays at a constant temperature rather than being continually turned on and off. It is safe to leave it on for prolonged periods, if it is properly ventilated; and it uses less power than a 100 watt light bulb. (Some Apple IIIs are used for controllers and such: they may be left on for months at a time.) If you're going to be using your Apple III again within a few hours, leave

it turned on. You should, however, turn off the monitor: leaving it on decreases the life of its picture tube.



The electronic components in which the Apple III temporarily stores information, collectively called the main memory, are volatile: that is, whatever you've stored in it will disappear when you turn off the Apple III's power. This means that you shouldn't turn your Apple III off when you've just typed in a lot of information and haven't saved it anywhere. When you put information into your Apple III, make sure you save it onto a diskette or other mass storage device before you turn the computer off. The manual for the particular application or system you're using will tell you how to do this.

Installing Disk Drives

If you have additional Apple Disk III drives, now is a good time to install them. Your first disk drive, not including your built-in disk drive, plugs directly into the back of Apple III.

***** IMPORTANT *****

Before connecting or disconnecting
ANYTHING
on the Apple III,
TURN OFF THE POWER.
This is a *MUST*.

Unpack the disk drive and unwrap the long, flat cable attached to it. Look at the connector at the end of this cable: one side has a small rectangular bump on it. Hold the connector with this bump on top and plug the connector into the "FLOPPY DISKS" connector on the Apple III. The bump should slide into the matching notch in the Apple III's connector. Press the connectors together until they are firmly seated, but don't force them: if they don't go together easily, they are probably crooked.

If you have a second external disk drive, plug it into the back of the first disk drive in exactly the same way as you plugged that drive into the Apple III. A third external drive plugs into the second in the same manner. Your Apple III can support up to three external disk drives.

If you have two or more external drives, you will have to reconfigure your system before you can use all of them. How to do this is explained in the chapter "The Utilities Diskette".

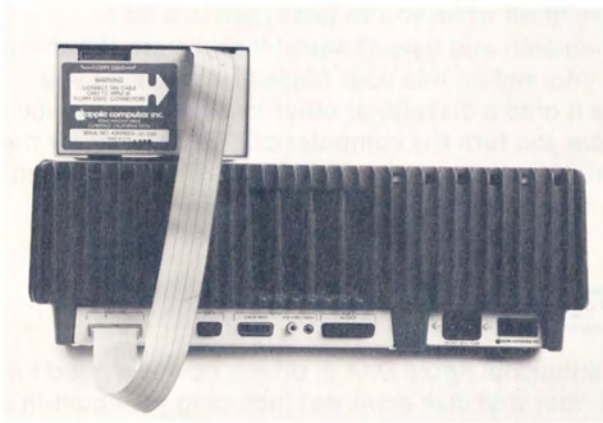

Attachment of External Drives



Do not attempt to attach more than three external disk drives to your Apple III! Even though you can physically attach more, the electronics in the Apple III cannot handle more than three external drives. Attaching more drives may damage the Apple III, the drives, or both.

We will tell you how to install other devices in the section "The Back", in the chapter "The Machine".

Using Your Apple III

Standard Procedures

This chapter will guide you through your first hands-on experience with the Apple III and show you how to use its standard operating procedures. The techniques explained in this chapter will be useful to you every time you use your Apple III, no matter what language or application you are using.

A note about the examples: parts of this chapter will ask you to run a program on the Apple III and try out the commands. It's important that you actually try the examples so that you see what they do and how they are used. The examples were written with the assumption that you have the Apple III set up and running, and that you are doing the examples as they are presented. If you read the manual without actually trying everything on the Apple III, or if you try to learn how to use the Apple III without reading the manual, you may not learn how to use some of the powerful functions of the Apple III.

Even though the manual shows you many ways to use the features of the Apple III, there are still very many more ways to use them. So play and experiment: try new and different things. It's the only way you'll learn the true power of your Apple III.

The Usual Startup Procedure

You use the same general procedure to start up your Apple III each time you turn it on. It's the same procedure you used to start up the Demonstration diskette in the last chapter. This procedure is called a *bootstrap* operation, or "booting the system". The term dates back to the early days of computing and refers to the steps the computer takes to load the software it needs to operate, as if it were tugging on its own bootstraps.

The usual procedure for booting your Apple III is to insert a diskette in the Apple III's built-in disk drive, close the drive door, and turn the power switch on. If the power is already on, the procedure for booting is to hold down the CONTROL key while you press and release the RESET button behind the keyboard.



Booting Up

As soon as you release the RESET button, the disk drive's red light comes on and the drive starts to whirl. In a matter of moments the computer will have taken the information it needs from the diskette and started running a language or special program. The amount of time that it takes the computer to read the needed information varies from application to application.

Boot Diskettes

You must boot your Apple III using a diskette that has been specially prepared for that purpose. Such a diskette is called a *boot diskette*. A boot diskette is just like any other diskette, except that it contains three special things:

- An operating system. This is a program that controls the machine's operation in a uniform manner.
- A set of device drivers. These are smaller programs that enable the operating system to communicate with

input/output devices such as the keyboard, screen, printer, and disk drives.

- An interpreter. This is a program that lets the Apple run programs written in a given language, such as Apple Business BASIC, Apple Pascal, or even VisiCalc.

Every boot diskette must contain these three items. If you try to boot your Apple III using a diskette that lacks one or more of these, the Apple III will respond with the message

KERNEL FILE NOT FOUND

or something similar, and then “hang” (do nothing) until you insert a proper boot diskette and try again.



Whenever you boot a diskette, you automatically boot a language. The only way to switch from one language to another is to reboot the system with the other language's boot diskette.

Turnkey Systems

Most boot diskettes also have a fourth important item: a program that runs automatically whenever you boot the Apple III using that diskette. Such diskettes are called *turnkey diskettes*. Suppose a doctor has a program that schedules patients' appointments. Ideally, the office staff should be able to turn on the Apple III and immediately begin using the appointment system. The staff members wouldn't need to know anything about the program or languages, just how to use the appointment system. As far as they are concerned, the computer is simply an appointment maker.

This is the essence of a turnkey system: from the user's point of view the computer is simply a device for one particular application, and getting it started is as simple as turning a key in a lock. Here, the “key” is the Apple III's power switch. A well-designed turnkey system can be operated by anyone.

The Demonstration diskette you used in the first chapter is a turnkey diskette; so is the Apple III Utilities diskette, which you will use later on in this chapter. Many of the programs you buy for your Apple III will be on turnkey diskettes. If you are going to be writing your own programs, you can learn how to create turnkey diskettes by reading the manual for the programming language you are going to use.

Using the Console

Together, the Apple III's video display and keyboard are called the *console*. Through the console, you send information to, and receive information from, the program or application you are using. Just as you use the dashboard and pedals of your car to control the car and monitor its operation, you use the console of your Apple III to control and monitor everything the Apple III does.

There are standard ways that the console lets you enter information and standard ways that it displays information on the screen. Whatever application you are using, you will usually use the console in the same general way.

The best way to learn about the console is to use it. There's a program on the Demonstration diskette that allows you to use the console alone, without using another application or program. This will give you practice in using the general features of the console. Think of it as a driving simulator. Once you have learned the mechanics of driving, you are prepared for all the different conditions you may encounter.

To use this program, place the Demonstration diskette in the Apple III's built-in disk drive and use the standard procedure for booting diskettes, described above. Once the demonstrations start, press the ESCAPE key on the Apple III's keyboard. You should see the Demonstration menu:

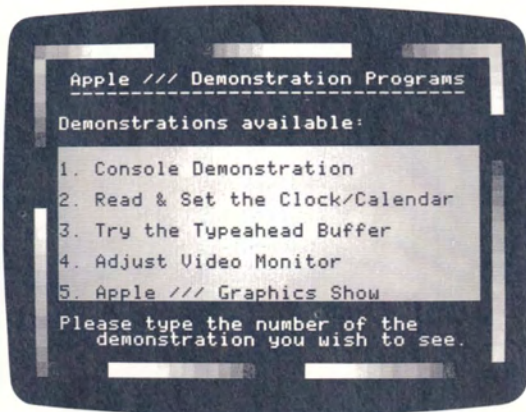

The Demonstration Menu

Choose the **CONSOLE DEMONSTRATION** by pressing the number 1. Immediately the disk drive will start to whirl, and after some introductory instructions, the screen will go blank, with a small white square in the upper-left corner. Try typing something. As you press each key, its character will appear on the Apple III's screen. (The 128 different characters that the Apple III can display on its screen are called its *character set*.)

This demonstration program reads each character you type from the keyboard and immediately writes it onto the screen. The process of automatically displaying everything that is typed is called *echoing*.

Most programs and applications echo the characters you type, but they also interpret what you're typing. Some programs examine each keystroke for meaning as soon as you type it; others wait until you hit a special key (such as **RETURN** or **ENTER**), or until you type a certain number of characters, before they look at what you've typed.

The following exercises acquaint you with the the most common uses of the console: typing, erasing minor mistakes, and controlling the display on the screen.

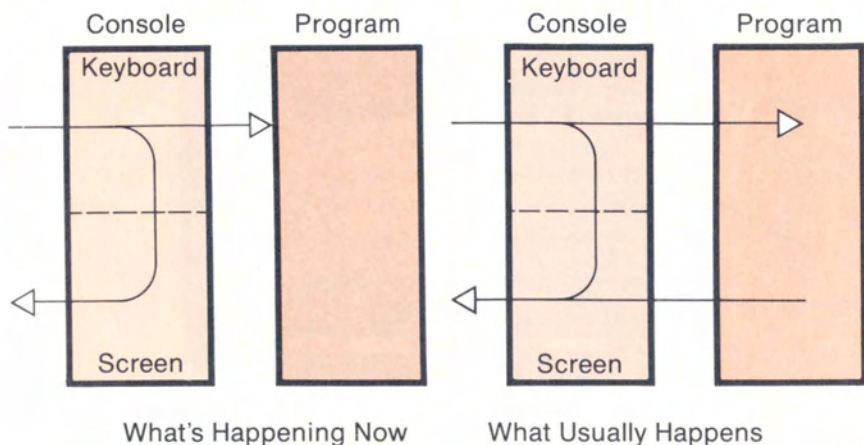

The Keyboard

Look closely at the keyboard. You'll see that it looks much like the keyboard on an office typewriter. Type characters until you get to the end of a line, then press the RETURN key to start the next one.



Typing

You'll notice that the Apple III's keyboard is somewhat different from a typewriter's keyboard. First, the keys operate simple switches rather than complicated mechanisms, so you don't have to press hard on them. Second, the keycaps are curved and sloped for easier, more

comfortable typing. There's also a little bump in the middle of the D and K keys, and one on the number 5 on the numeric keypad (to the right of the main keyboard). If you're a touch-typist, you'll know you're in the home position when you feel those little bumps with your middle fingers.

The keyboard has several symbols that are not usually found on typewriters:

Vertical Bar	
Backslash	\
Tilde	~
Grave Accent	`
Brackets	[]
Braces	{ }
Angle Brackets	< >
Circumflex	^

These symbols are included because many programming languages use them. But the keyboard lacks two characters often found on typewriters: the cents sign and the plus-or-minus sign.

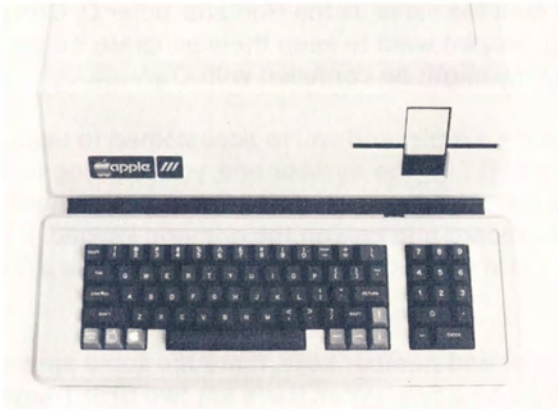

The Keyboard

The group of 13 keys to the right of the typewriter keyboard is called the *numeric keypad*. The keys on the keypad are grouped like those on an adding machine or calculator, to make it easier to enter large amounts of numerical data into the Apple III. The keys on the numeric

keypad usually work the same as their main-keyboard counterparts (ENTER is the same as RETURN), but programs can redefine their meanings (as well as the meanings of most other keys) to distinguish them from the number keys on the main keyboard.

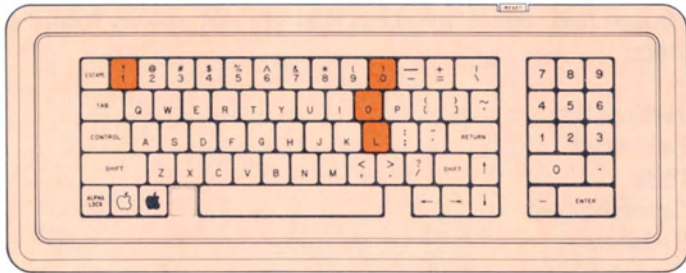

Type a few zeros, using the zero keys both in the top row of the main keyboard and at the bottom of the numeric keypad, and look at the characters displayed on the screen. The slash through the zero is meant to distinguish it from the letter O. When the Hindus were inventing the number system we use, they used a symbol for zero which didn't interfere with any letter in their alphabet; but their zero happened to look the same as the Romans' letter O. Computers (and clear-thinking people) want to keep them separate, so we slash our zeroes when they might be confused with O's.

Similarly, if you're a typist and you're accustomed to using the lowercase letter l (L) for the number one, you're going to have to readjust. There are two keys you can use to type the number 1 : one on the main keyboard and one on the numeric keypad. If you use an l for a 1 the Apple III will get wrong information, so use a 0 for zero and a 1 for one.

Besides the letter and number keys, there are some special keys on the keyboard. As on a typewriter, there are two SHIFT keys, one on either side of the keyboard. When you hold down one of the SHIFT keys, you change the meaning of other keys on the keyboard.

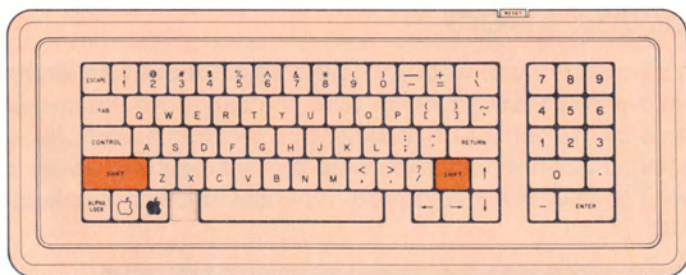

Some keys (mostly along the top row) have two symbols on them. When you press the key alone, the lower character on that key appears on the screen. If you hold down SHIFT while pressing the same key, you'll get the upper character on the key.

You've seen that when you press the letter keys on the keyboard, lowercase letters appear on the screen. By holding down SHIFT, you can type uppercase letters. Experiment with typing lowercase and uppercase letters and other shifted characters. Try pressing the ALPHA LOCK switch and typing letters and numbers: notice that it works like an automatic shift for letters only.

Have you been noticing the little white square, which moves along the screen as you type? It's called the *cursor*, and it serves two purposes. First, it is an indication that the Apple III is waiting for you to type something. When the Apple III is waiting for you to type something on the keyboard, it usually displays a cursor. Second, the cursor indicates the position on the screen where the next character you type will be placed. Each time you press a key, the computer writes a character at the cursor position on the screen and moves the cursor to the right, like the printing element on a typewriter.

Correcting Errors

Nobody's perfect. If you've been typing a fair amount it's likely that you have pressed a wrong key or two. You can move the cursor backwards to correct your mistakes; this is called *backspacing*, and the key you use is the *backspace key*, the left-pointing arrow in the lower-right corner of the keyboard. Type this line from Shakespeare's Sonnet 30:

```
When to the sessions of sweat silent thought
```

Immediately you see you've made a mistake. Naturally, "sweat" should be "sweet". So use the backspace key to move the cursor back to the *a*. Now type an *e*, and the error is gone. The *e* replaces the *a*: this is called *overstriking*.

```
When to the sessions of sweet silent thought
```

This is the general method of correcting typographical errors: backspace and overstrike. But each time you backspace over a character, you are actually telling the Apple III to forget that you ever typed that character. This type of backspace is called a *nondestructive backspace*: it leaves all characters intact on the screen.

If you were to press RETURN now to begin the next line, the remainder of the line you typed would be erased, because by backspacing over it you told the Apple III to forget it. Before you press RETURN, you must move the cursor back to the end of the line.

There are two ways to do this: you can either type the rest of the line yourself (not very convenient if you have to correct the first word of a long sentence), or you can use the right-arrow key, called the *retype* key. Each time you press this key, the cursor moves one space to the right. To the Apple III, it's as if you had typed the character under the cursor. Press the right-arrow key sixteen times, to move the cursor to the right of the word "thought". The Apple III thinks you just typed "t silent thought", the sixteen characters you moved over.

```
When to the sessions of sweet silent thought
```

You can use this technique—backspace, overstrike, and retype to where you left off—whenever you detect a minor mistake in the middle of a line you're typing.

But what if you type a line, then change your mind and want to delete the entire line and start again? You could backspace to the beginning and type the correct line, or you could tell the Apple III to cancel the *entire* line (everything you've typed since you last pressed RETURN) by holding down the CONTROL key and typing the letter X.

Practice cancelling lines. Press RETURN to skip to a new line and type the next line to Sonnet 30:

```
I sigh the lack of many a thing I sought
```

Oops . . . this is the third line of the sonnet, not the second. To tell the Apple III to forget this line so you can start again, hold down CONTROL and type an X. The Apple III responds by typing a backslash, skipping a line, and waiting for you to retype the line.

```
I sigh the lack of many a thing I sought\
```

The act of holding down the CONTROL key while pressing some other key is called typing a *control character*. The CONTROL key works similarly to the SHIFT key: both keys change the meaning of other keys on the keyboard (however, some programs choose to ignore this change). The Open and Closed Apple keys can be used for a similar purpose: to give multiple meanings to a single key.

Control characters do what their name implies: they control the operation of a program or application. Depending upon the application you're using, you may be asked to type many different control characters at various times. This and other manuals will use the phrase "type CONTROL-L", for example, to mean "hold down the CONTROL key while typing the letter L".

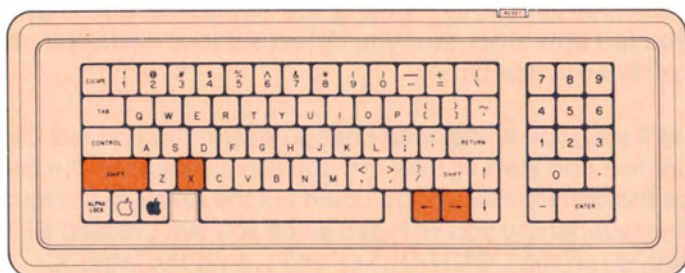

You'll use backspacing and cancelling like this when you're using programs written in languages like BASIC. But some systems, such as Pascal, use a *destructive backspace*. A destructive backspace works just like the nondestructive backspace you've just seen, except that the characters you backspace over are removed from the screen. A language or application usually uses only one type of backspace, destructive or nondestructive. You can't normally change which type of backspace you're using, but this demonstration has a special command which allows you to do just that. To see how a destructive backspace works, hold down the Open Apple key and press the spacebar.

Correctly type the second line to the sonnet:

```
I summon up remembrance of things past
```

Now use the backspace key to go back and change "of" to "about". See the characters disappear? That's destructive backspacing. Each character is erased as you back over it. To fix an error in a line when you're using destructive backspace, you must back up to the error, correct it, and type the rest of the line again. The retype key works like the spacebar when you're using destructive backspacing. Try it.

```
I summon up remembrance about
```

When backspacing is destructive, so is cancelling lines. Type the fourth line of the sonnet:

```
And with old woes new wail my dear time's waste.
```

But these memories are unsettling: let's cancel this line.

Type CONTROL-X (Remember how? Hold down CONTROL and type an X). Instead of cancelling the line as before, CONTROL-X now erases the entire line you typed, and leaves the cursor at the beginning of the same line.

Wrapping and Scrolling

Type the preamble to the U.S. Constitution, or any other sentence more than eighty characters long. When you get to the right edge of the screen, don't press RETURN: just keep typing and see what happens. Since the screen is only eighty characters wide, the whole sentence doesn't fit. If you were typing on a typewriter and you reached the right side of the page, the typewriter would probably stop at the right margin and stop printing characters; you'd have to press the carriage return to proceed. But on the Apple III, whenever the cursor gets to the right side of the screen, it automatically jumps to the beginning of the next line. Sometimes it splits a word in two, leaving the beginning on one line and the end on the next. This technique is called *wraparound*: it's as if the screen wrapped around behind itself so that the right edge connects to the left edge. When the cursor reaches the right side of the screen, its next position is the first character of the next line.

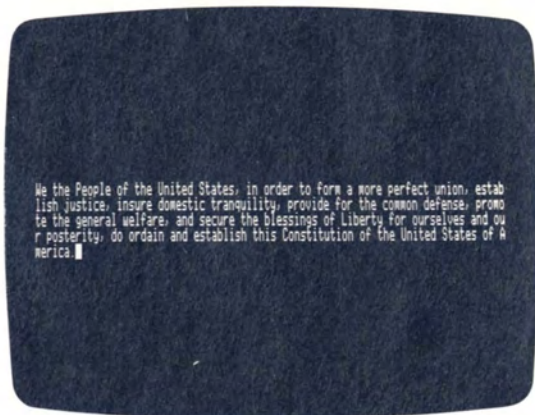

Wraparound

If you don't like wraparound, then you can do just as you would on a typewriter: when you approach the right side of the screen, press the RETURN key. Pressing RETURN sends the cursor to the beginning of the next line on the screen. In most real applications, RETURN also signals the Apple III that you've finished typing something, and that you want it to process what you've typed.

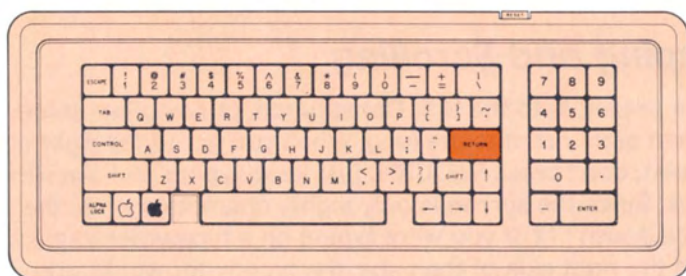

If you type enough text, or press RETURN often enough, you'll fill up the screen. When the cursor reaches the bottom line of the screen, and reaches the right edge of that line (or you press RETURN), it has nowhere to go: there is no "next line". So the Apple III *scrolls* the screen, rolling it up one line, and gives you a fresh, blank line at the bottom. Try it: press RETURN enough times to get down to the bottom of the screen, type something, then press RETURN again. All the text rolls upwards, the top line vanishes, and a new blank line appears at the bottom. If you press RETURN several more times, you can scroll the text clear off the top of the screen.



Scrolling: Before and After

Try holding a key or key combination (like the exclamation point, SHIFT-1) down for a few seconds. The moment you press it, you get one exclamation point (as you expected). But after half a second, you start getting more and more exclamation points. It's as if you were pressing that key repeatedly, 11 times per second. Every *standard* key—that is, every alphabetic, numeric, and symbol key—on the keyboard automatically repeats if you hold it down for more than half a second.

Now without letting up on SHIFT-1, press the Closed Apple key, the key to the left of the spacebar. (The key to the left of the Closed Apple key is called the Open Apple.) Not only do you get more exclamation points, but they come faster, too. When you press and hold the Closed Apple key while holding down any other standard key, you will get that key repeated at a rate of about 33 keystrokes per second. The four arrow keys also repeat automatically at this faster speed if you press down firmly on them. The arrow keys act like a two-speed transmission, with slow and fast speeds.

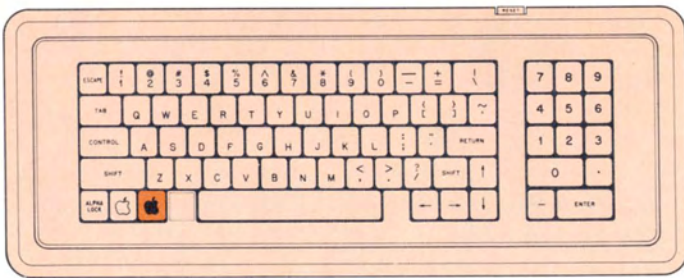

Leaving the Demonstration

The most common uses of the console are the ones you have just demonstrated: typing and correcting minor errors. There's another demonstration on the Demonstration diskette that introduces the type-ahead feature. Type-ahead enables you to type information faster and more efficiently. You may want to experiment with that demonstration as well, but first you must stop the console demonstration you're now using.

To leave the console demonstration and return to the demonstration menu, hold down the Open Apple key and press ESCAPE. Now you can try the typeahead demonstration, if you wish.

The console has some other features you may wish to use. The operation of the console is described in full in the Apple III Standard Device Drivers Manual, which accompanies this manual.

The Operating System

About SOS

The central piece of software that runs on your Apple III is the Sophisticated Operating System, called SOS (pronounced “sauce”). The purpose of SOS is to provide an efficient, consistent, and flexible means for programs to use the hardware of the Apple III. All programs communicate with the computer’s hardware and input/output devices through SOS and only through SOS.

You don’t interact directly with SOS: only advanced programmers who work in machine language will use SOS directly. But as all systems and languages you will be using on the Apple III themselves use SOS, it is important to have a basic knowledge of SOS.

A Disk-Based System

SOS is included on every boot diskette you use to start up your Apple III. Because of the size, complexity, and power of SOS, it is possible that newer, improved versions will be released as time goes on. Unlike those personal computers whose operating systems are stored in permanent memory, the Apple III enables you to move up to a newer version of SOS easily, quickly, and inexpensively, simply by updating your SOS diskettes.

Devices

The Apple III communicates with the world through *devices*. A device is a part of the Apple III, or a piece of external equipment, that can

transfer information into or out of the Apple III. Devices include the keyboard and screen, disk drives, and printers.

SOS recognizes two kinds of devices: *character devices* and *block devices*. A character device is mainly used to get information into or out of the system, and a block device is mainly used to store and retrieve information.

Special programs called *device drivers* take the streams of characters coming from SOS and convert them to machine actions, or convert physical actions of the machine into streams of characters for SOS to process. Device drivers for the standard Apple III peripherals are included in SOS: you can change or delete these, or add new ones, by using the System Configuration Program option on your Utilities Diskette. These operations will be explained in the chapter "The Utilities Diskette". For more information on the System Configuration Program and device drivers, see the Apple III Standard Device Drivers Manual.

Trying to refer to a device for which SOS has no device driver, even though the hardware for that device may be physically installed, will get you some kind of error message. Similarly, if you have a device driver but you don't have the device installed in your Apple III, SOS cannot use it until you connect it and turn it on.

Character Devices

Character devices send or receive streams of characters, one at a time. The console (screen and keyboard), serial interface, and printer are all character devices. Some character devices, like the keyboard, are input devices: they take characters into the computer. Some, like the screen, are output devices: they take characters out of the computer. Others, like the serial interface, are input/output devices, and take characters in and out.

Block Devices

A block device is any device that stores information in blocks of 512 characters and that can retrieve any given block on demand. All disk drives and other external memories are block devices. Files (except

device files, which will be explained later) can be stored only on block devices.

Device Names

Every device that can be connected to the Apple III is accessible to SOS through its device driver, which is referenced by its *device name*. A device name is up to 15 characters long: the first is a period; the second is a letter; the rest can be either letters or numbers, in any combination. Some legal device names are

```
.D1
.PRINTER
.BLOCKDEVICE
```

some illegal device names are

```
PRINTER      (the first character is not a period)
.BLOCK.DEVICE (only the first character can be a
              period)
.BLOCK DEVICE (a device name cannot contain a
              space)
.BLOCK/DEVICE (a device name cannot contain a /)
```

In addition to its device name, a block device is accessible by its *volume name*. The volume name of a block device is the name of the volume currently in the device; the volume name of a floppy-disk drive will change as you insert and remove diskettes. A block device containing no volume (such as a disk drive without a diskette, or with an unformatted diskette, or with its door open) has no volume name and, to SOS, does not exist. A volume name is up to 15 characters long: the first is a letter; the rest can be letters, numbers, or periods. A volume name is always preceded by a slash (/).

Here are a few legal volume names:

```
/PROGRAMS
/BLOCK.FILES
/CHAP.2B
```

Here are some volume names that will *not* work, and the reasons why:

/BAD NAME	(contains a space)
/1.TO.10	(first character is a number)
/STEVE'S.PROGRAM	(contains an apostrophe)
/ANTHROPOMORPHOUS	(more than 15 characters)

Files

A *file* is a named, orderly collection of information. Files are used to store, transmit, or retrieve information. Files can hold numbers, programs, business letters, phone lists, or any other kind of information you can put into your Apple III.

All files have names. When you want access to the information stored in a particular file, you refer to that file by its name.

Where to Find Files

Files can be stored in many different places in and around your Apple III. One place for a file to reside is on a block device, such as a disk. When a file has been stored on a disk, the information in that file is permanent and is not lost when the power is turned off, nor when you remove the disk from the Apple III (if the disk is removable). But to change the information in a file stored on a disk, you must load the relevant information from the file into memory, change it there, and then store it back onto the disk.

Another place for a file to reside is on a character device. SOS treats devices such as the console (the screen and keyboard), the printer, and the serial port as files. To print information on a printer, for example, you simply write it to the *device file* named `.PRINTER`. Device files differ from files on block devices in two ways: all device file names must begin with a period, and there are some restrictions on how you can read from and write into device files (for example, you can't read from a printer).

A file can not be stored in the Apple III's memory. The information in the file can be read into memory, changed there, and written out to a file; but the information in memory is not a file. It has no name, and it has no permanence: if you turn the Apple III off, the information goes away.

Directory Files

Whereas character devices are single files, block devices can contain dozens, perhaps hundreds, of files. To help you organize your files so you can easily locate a particular file when you need it, SOS allows you to group the files on a block device together, using *directories*. A directory is a file whose contents are the names and locations of other files on the volume. The directory's name is the volume name of the block device it's in. For example, when SOS looks at a diskette, all it sees is one file, the directory file for that diskette. To find the names of all of the files on a diskette, you simply look at the contents of the directory file. The list of the contents of a directory file is also called a *catalog*.

Local Names

A *local name* is the name of one entry in a directory: it can be a file containing your data, or it can be a directory file. Local names are composed of up to 15 letters, numbers, and periods. A local name must begin with a letter. The Apple III automatically converts all lowercase letters in a local name to uppercase.

Here are a few legal local names:

```
MIKE.2.JULY.80
SORTPROGRAM
LETTER.TO.SUE
```

Here are some names that will *not* work, and the reasons why:

BAD NAME	(contains a space)
1.TO.10	(begins with a number)
STEVE'S.PROGRAM	(contains an apostrophe)
ANTHROPOMORPHOUS	(more than 15 characters)

Subdirectories and Pathnames

At the very top level, SOS thinks that you've only got a few files: some device files and some directory files. That's all it sees. But each directory file points to some files on that block device, and any of those files can be a *subdirectory* that points to some more, and so on. By using directories and subdirectories properly, you can build a hierarchical storage system whose structure reflects the relationships between the pieces of information you're storing.

For example, a diskette named PROGRAMS may contain, among other files and subdirectories at its top level, the subdirectory SORT.ROUTINES. Among the files in that subdirectory may be the file ALPHASORT. It may be referenced by the *pathname* /PROGRAMS/SORT.ROUTINES/ALPHASORT . A pathname is simply a volume name followed by a series of local names: the whole pathname is preceded by a slash, and the component names within it are separated by slashes. The pathname specifies the "path" that SOS must take to find a given file: first it reads the volume directory, then looks in a subdirectory for the location of the next subdirectory, and so on until it finds the last-named file. In this case, the directory of the volume PROGRAMS tells how to find the subdirectory SORT.ROUTINES, which tells how to find the file ALPHASORT (. . . which lived in the house that Jack built.)

Block device names let you refer to a particular block device without knowing the name of the volume it contains. When SOS sees a device name at the beginning of a pathname, it automatically substitutes the name of the volume contained in the specified device for the device name in the pathname. The Apple III's built-in disk drive has the device names .D1 ; the additional disk drives are named .D2 , .D3 , and .D4 , respectively. Hence, a file named A.THURU.D in the volume directory of a diskette named NAMES that is in the Apple III's built-in drive can be referred to either as

/NAMES/A.THURU.D

or, by using the device name, as

.D1/A.THURU.D .

An Example: Widgets, Incorporated

Widgets, Incorporated, a wholly owned subsidiary of Donothing Gadgets Ltd., has offices in a building on Fourth Street. When you walk into their offices, you see three large filing cabinets against the wall:



The Widgets, Inc., Filing System

The left cabinet is labeled ACCOUNTING, the right cabinet is labeled PERSONNEL, and the center cabinet is labeled INVENTORY.

The ACCOUNTING file cabinet has one drawer marked PAYABLE and one drawer marked RECEIVABLE. In each drawer are a lot of file folders, one folder for each company that has an open account with Widgets, Inc.

The PERSONNEL file has drawers marked CURRENT EMPLOYEES, FORMER EMPLOYEES, and COMMUNICATIONS. The first two contain individual file folders for each current or former employee. The last drawer has a divider down the middle, separating INTERNAL from EXTERNAL communications. The INTERNAL side contains file folders for each person who's ever sent a memo, and each folder contains every memo that person has sent. The EXTERNAL side contains all the documentation of Widgets' products, in no particular order.

In block diagram form, this is how the files are organized:

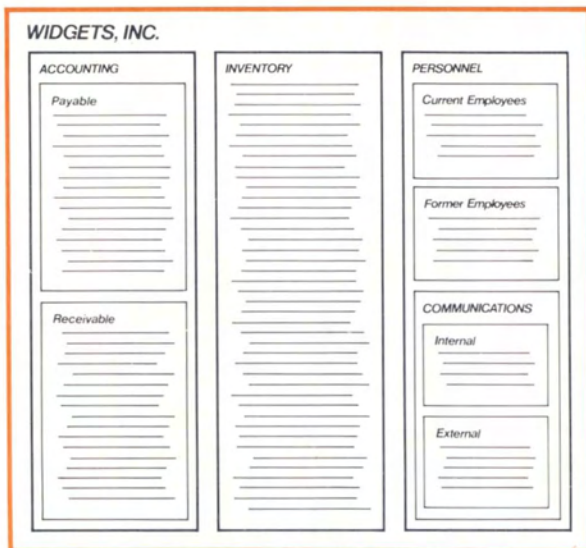

The Widgets, Inc., Hierarchy

You are in charge of maintaining these file cabinets, getting things from them, and filing things away in them. If somebody wanted to write a letter of recommendation for Sam Johnson and asked you for Sam's personnel file, you would go to the PERSONNEL filing cabinet, look in the FORMER EMPLOYEES drawer, and find the file for Sam Johnson. If you wanted to find out how much was owed to the Quigley Supply Company, you would go to the ACCOUNTING cabinet and look in the PAYABLE drawer for the Quigley file folder. If Steve Atkins gave you a copy of a memo he wrote, you would go back to the PERSONNEL cabinet, open the COMMUNICATIONS drawer, look in the INTERNAL side for Steve's file, and drop the memo in with all of the other internal memos Steve has sent.

(For the sake of brevity in the example, the contents of the INVENTORY cabinet and the other drawers in the other cabinets will not be discussed here.)

If you wanted to store all of Widgets' records on the Apple III, you could set up the filing system in exactly the same way. The filing cabinets correspond to diskettes:



Diskette = Filing Cabinet

Each diskette takes the same name as the file cabinet it's replacing: this name is called the *volume name* of the diskette. The diskette's main, or *root*, directory is also identified by this volume name. So the ACCOUNTING diskette's root directory would contain (in addition to some standard program files) the files named PAYABLE and RECEIVABLE, which would correspond to the drawers in the filing cabinet. These files themselves would be subdirectories. The PAYABLE subdirectory would contain files named QUIGLEY, ACME, and so forth, which would contain the same information that was previously in the individual file folders.

The structure is the same throughout the rest of the filing system. The PERSONNEL diskette contains three subdirectory files: CURRENT, FORMER, and COMMUNICATIONS. The COMMUNICATIONS subdirectory contains subdirectory files called INTERNAL and EXTERNAL; INTERNAL contains subdirectories for ADAMS, SMITH, JOHNSON, ATKINS, and all the rest of the memo senders, and finally the subdirectory ATKINS contains a file for each memo Steve Atkins has sent.

Using Pathnames

If you wanted to get that employee file for Sam Johnson, you would tell SOS how to locate that file by supplying a pathname. The

pathname of Sam Johnson's employee file, which has the local name JOHNSON , is

`/PERSONNEL/FORMER/JOHNSON`

(just like PERSONNEL cabinet, FORMER drawer, JOHNSON file). The pathname for the Quigley accounts payable file is

`/ACCOUNTING/PAYABLE/QUIGLEY`

and the name of the individual memo that Steve Atkins sent on March 15 might be

`/PERSONNEL/COMMUNICATIONS/INTERNAL/ATKINS/
MARCH.15`

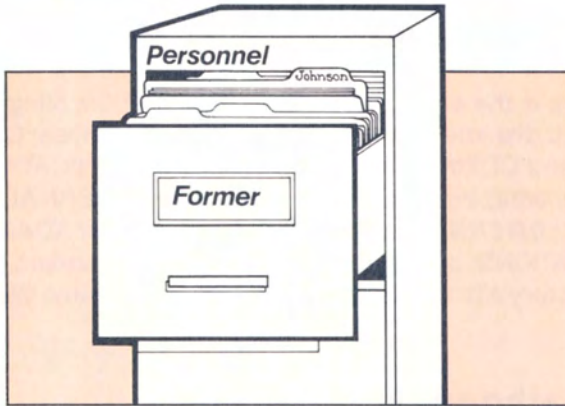

`/PERSONNEL/FORMER/JOHNSON`

(The period is in MARCH.15 because a pathname cannot contain a space.)

If the volume PERSONNEL is in .D2 , this pathname could be written `.D2/FORMER/JOHNSON` , using the block device named .D2 . Each file has one pathname, and each pathname specifies only one file. Even if you have two files with the same local name, such as accounts payable to and receivable from Quigley, you can still tell them apart by their pathnames. One would be named

`/ACCOUNTS/PAYABLE/QUIGLEY`

and the other would be

```
/ACCOUNTS/RECEIVABLE/QUIGLEY
```

Even though the two files have the same local name, they are different because they have different pathnames.

The Prefix and Partial Pathnames

It would be inconvenient to have to specify a complete pathname whenever you wish to locate a file. For example, if you wanted to look at all the memos Steve Atkins has sent, you wouldn't want to have to type the entire forty- or fifty-character pathname of each memo. SOS avoids this problem by means of a stored pathname called the *prefix*. The prefix is a pathname that specifies a directory or subdirectory. Once you have set the prefix, you can refer to any file in the prefix directory by its local name alone. So if you were reading Steve Atkins' memos, you would set the prefix to

```
/PERSONNEL/COMMUNICATIONS/INTERNAL/ATKINS
```

and refer to the individual memos by their local names: MARCH.15 , PURCHASEPLAN , RELEASESCHED , and so forth. Setting the prefix is like bringing just one drawer from the filing cabinet over to your desk: you know you won't need the contents of all three cabinets at your fingertips, only the files in the drawer you have.

You can set the prefix to the pathname of any directory or subdirectory, as explained in the section "set Prefix" in the chapter on the Filer. Individual application programs and languages have other ways of setting the prefix, which are explained in their respective manuals. If the prefixed directory has subdirectories, you locate the files in the subdirectories by using *partial pathnames*. A partial pathname is the pathname from the prefix directory to a given file. If you were going to be looking at all the employee files, both current and former, you might set the prefix to /PERSONNEL ; you could then refer to current employee George Simpson's file by the partial pathname

```
CURRENT/SIMPSON
```

and former employee Sam Johnson's file by the partial pathname

FORMER/JOHNSON

Even when you set the prefix, you can still get to any other file in the system by supplying its full pathname. The prefix is only used when you supply a pathname that does not begin with a slash or period. (Thus pathnames that begin with device names will never have the prefix applied by SOS.) If you set the prefix to /ACCOUNTING , you can still locate a memo you sent about the Quigley account by the full pathname

/PERSONNEL/COMMUNICATIONS/INTERNAL/
YOURNAME/QUIGLEMEMO

without changing the prefix. You can also locate the Quigley receivable file by the partial pathname

RECEIVABLE/QUIGLEY

and use the account auditing and balancing program (stored in the directory /ACCOUNTING) with the local name

AUDIT.BALANCE

all without changing the prefix.

When you boot SOS, the prefix is automatically set to the volume name of the boot diskette.

Using Files

Among the standard operations you can perform on disk files are reading information from them into memory, storing information from memory into them, creating new files and destroying old ones, changing their names, and setting some other miscellaneous information about them. You can also set the prefix and find out what the current prefix is.

Languages and applications on the Apple III will have slightly different names for each of these procedures, and slightly different ways of using them; the manuals for the language or application you're using will describe exactly how to perform the file manipulations. But a file is a file is a file, and directory files are directory files whatever you're doing on your Apple III.

You'll also see other types of files. Besides directory files, there are program files, data files, random-access files, and sequential-access files, but they're still all files and they're all manipulated in the same ways.

Also, don't let the complexity of the Widget company's files scare you. You'll rarely build hierarchies of such complexity on the Apple III. If you are using diskettes, you might have different diskettes for different purposes, and maybe a few subdirectories on each diskette, but you'll find that you usually won't need more than one or two levels of subdirectories on any one diskette. The important thing is that the capability is there. If you acquire a disk drive with more capacity sometime in the future, you'll want to use the full power of pathnames and prefixes.

The Utilities Diskette

Now find the diskette labeled APPLE III SYSTEM UTILITIES, insert it in the built-in disk drive, and boot it by turning on the power or pressing CONTROL-RESET.

The Utilities diskette does three things:

- *Operations on devices*, such as formatting volumes to hold data and copying the contents of one volume onto another.
- *Operations on files*, such as transferring, deleting, and renaming.
- *Configuring the operating system* so that it knows what devices are connected to your Apple III, and has the device drivers to handle them.

This chapter will tell you how to back up your diskettes, how to configure your system, and how to format blank diskettes. The next chapter will explain operations on files and devices.

When you boot the Utilities diskette, the first thing you see on your screen is the Utilities Diskette Main Menu:

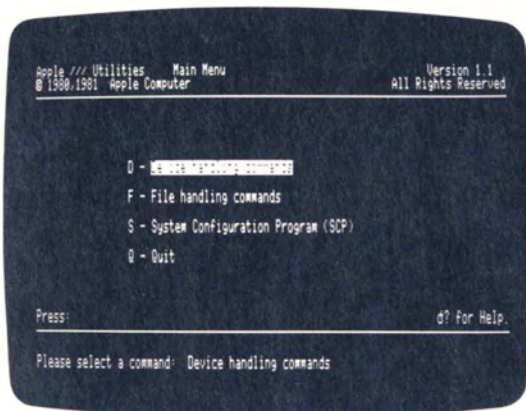

Utilities Diskette Main Menu

This menu works much like the menu on the Demonstration diskette: to perform one of the functions listed on the menu, you type the letter associated with that function.

Backing Up the Utilities Diskette

The next thing you need to know is how to make a backup copy of a volume. It is very important to make at least one backup copy of every volume containing valuable software or information. For this you will use the Copy-volume command, so called because it copies information a whole volume at a time. The Copy-volume command will use two volumes: a source volume, which is the volume containing the information to be copied, and a destination volume, which is the volume onto which the original information will be copied.

You can use almost any volume for the destination volume: the Copy-volume command can copy onto formatted blank volumes, unformatted volumes, or volumes that already have information on them. The two volumes and their respective devices must be of the same kind: a Disk III and a Disk II for the Apple III are of the same kind; a Disk III and a rigid (hard) disk are not. For copying between

volumes of different kinds, see the Copy-files command in the chapter "The Filer."

The Copy-volume command makes an exact copy of the source volume on the destination volume; any information previously on the destination volume will be lost. If you attempt to copy onto a volume that already contains some information, the Copy-volume command will ask you to verify that you do indeed want to destroy the previous contents of that volume.

To make a copy of a volume, choose option

D - Device handling commands

from the Main Menu by typing D . You will get this menu:

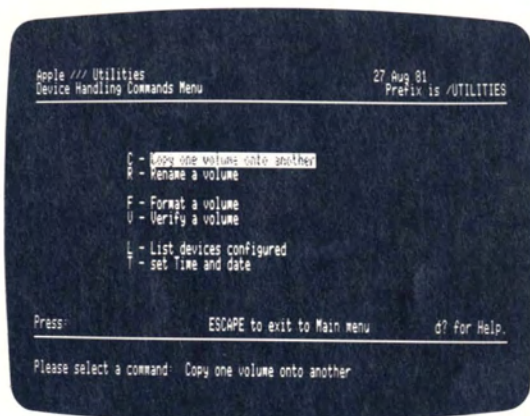

Utilities Diskette Device Menu

Then choose option

C - Copy one volume onto another

from the Device Menu, to get this screen:

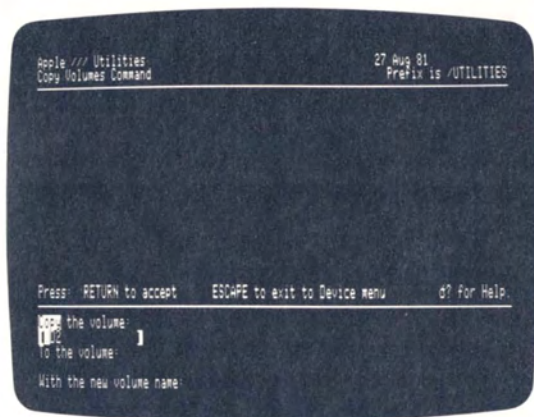

Copy one volume onto another

For now, let's make a backup copy of the Utilities diskette itself. You'll need two diskettes: the Utilities diskette and one blank diskette. As the Copy-volume command works with two volumes, it's helpful to have two disk drives. If you have only the built-in disk drive, you can still make copies, but you have to swap the diskettes in and out of the one drive. See the section "Copying with One Drive", below.

Write-Protection

Compare the Utilities diskette and a blank diskette. You will notice that the blank diskette has a notch on its right side, and the Utilities diskette does not. This notch tells the Apple III that it is OK to write on the diskette. The Utilities diskette, which has no notch, is *write-protected*: you can't write on it. Most Apple software is distributed on write-protected diskettes, to protect the software from getting erased accidentally.

You can protect your own software and data, too. With blank diskettes you get a sheet of silver *write-protect tabs*. (They look like stick-on labels, but they're not—try writing on one.) If you cover the notch on a diskette with a write-protect tab (just fold it over the edge of the black diskette cover, one end on each face), the diskette will be write-protected.

Copying With Two Drives

The first, highlighted, field



asks you for the name of the device you are going to put the source volume in, and offers you a default, which you will not use, since the Utilities Diskette, the source volume, is already in the built in drive, .D1 . (If the Utilities diskette isn't already in the built-in disk drive, put it there now and close the drive door.) Then type .D1 (the device name for the built-in drive) and press RETURN. (Of course, if your source volume were in some other device, you would type the name of that device instead, or use the default if appropriate.)



If you mistype an input, backspace with the left-arrow key and type over your mistake.

The highlight will now be on this field:



Note that the default changed in response to your first input. We'll use drive 2, the first external disk drive, as the destination device. Insert the destination volume into drive 2, then press RETURN to accept the default.

The next field,



lets you give the copy a different name from the original, which is handy if you might have to use the two volumes at the same time. We won't, so just press RETURN.

Now press RETURN again to make the copy. The Copy-volume command has a safety feature to prevent you from inadvertently destroying valuable information. If the volume you insert in the destination disk drive is not blank, the copy program will ask



```
Destroy old /BLANK07 ? [Yes]
```

using whatever volume name it finds already stored on the destination volume. If you have inserted the wrong volume or made some other mistake, you can safely cancel the copy operation, without destroying any information, by typing N (for "No"). If you really intend to destroy the previous information on the destination volume, type Y (for "Yes").

When the copy is done, the Copy-volume Screen, with the fields as you left them, will be displayed. To make another copy of the Utilities Diskette, you need only insert another diskette in .D2 and press RETURN three times to accept the defaults. To go to the Device Menu, press ESCAPE. To go to the Main Menu, press ESCAPE again. You will notice that the ESCAPE key has a certain consistency of use. In general, it means "Return to the previous step or state."

Copying With One Drive

The procedure for copying volumes with only the built-in disk drive is much the same as the procedure for copying with two drives (explained above), except that you must repeatedly swap the source and destination volumes in and out of the single drive. The number of such swaps will depend on the amount of memory you have in your Apple III.

The first, highlighted, field on the copy menu



```
Copy the volume:
.D2
```

asks you for the name of the device you are going to put the source volume in, and offers you a default, which you will not use because you don't have an external drive. (.D2 is the default because the system thinks you have two drives until you use the System Configuration Program—explained in the next section.) The source

volume in this case is the Utilities diskette itself. If the Utilities Diskette isn't already in the built-in disk drive, put it there now and close the drive door. Then type `.D1` (the device name for the built-in drive) and press RETURN.

The highlight will now be on this field:

```
To the volume:
[02 ]
```

Insert the destination volume into the built-in drive, then type `.D1` and press RETURN.

The next field,

```
With the new volume name:
[UTILITIES ]
```

lets you give the copy a different name from the original, which is handy if you might have to use the two volumes at the same time. We won't, so just press RETURN.

The Copy-volume command has a safety feature to prevent you from inadvertently destroying valuable information. If the volume you insert in the destination disk drive is not blank, the copy program will ask

```
Destroy old /BLANK23 ? [Y]as
```

using whatever volume name it finds already stored on the destination volume. If you have inserted the wrong volume or made some other mistake, you can safely cancel the copy operation, without destroying any information, by typing N (for "No"). If you really intend to destroy the previous information on the destination volume, type Y (for "Yes").

The Apple III will now store all the information it loaded into its memory onto the destination volume. It will then ask you to insert the

source volume again. Open the door, remove the destination volume, and insert the source volume. Close the door and press RETURN. Repeat this procedure until you see the message

```
/UTILITIES ---> /UTILITIES
```

The program keeps track of which diskette is in the drive, so you needn't fear that you will forget whether you need to swap or not if, say, someone interrupts you while you are copying.

When the copy is done, the Copy-volume Screen, with the fields as you left them, will be displayed. To make another copy of the Utilities Diskette, you need only insert another diskette in the built-in drive and press RETURN three times to accept all the defaults. To go to the Device Menu, press ESCAPE. To go to the Main Menu, press ESCAPE again. You will notice that the ESCAPE key has a certain consistency of use. In general, it means "Return to the previous step or state."

Configuring Your System

The third option on the Utilities menu, the System Configuration Program (SCP), is used to tailor the system software on your boot diskettes to match the specific number and types of input and output devices connected to your Apple III. This process is called *configuring* your boot diskettes.

Every time you boot your Apple III, a *system configuration* is loaded into memory from the boot diskette. The system configuration includes a collection of special programs called *device drivers*, which enable the Apple III to communicate with input/output devices connected to it. Each type of input/output device has its own driver, designed specifically for that device. If the system configuration on the boot diskette doesn't contain a driver for a particular device, the Apple III will be unable to communicate with that device.

In addition to device drivers, the system configuration also includes certain special pieces of information called *system parameters*, such as the number of Disk III floppy disk drives connected to your Apple III, the keyboard layout, and the character set to be used for displaying text on the screen.

The Apple III's built-in input/output devices are controlled by *standard* device drivers. The boot diskettes supplied with your Apple III come preconfigured with some of these standard drivers. (Because of memory and disk space limitations, not every boot diskette contains all of the standard drivers.) The standard device drivers include the *console driver*, for communicating with the Apple III keyboard and displaying text on the screen; the *graphics driver*, for displaying graphics on the screen; the *printer driver*, for communicating with a printer through the Apple III's built-in serial interface port; the *audio driver*, for generating sounds on the Apple III's tone generator; the *RS-232 driver*, for communicating with a serial device; and the *Silentype driver*, for communicating with the Silentype printer. For complete information on the Silentype driver, see the *Silentype Manual*, for information on the standard drivers, see your *Apple III Standard Device Drivers Manual*.

In addition to the standard drivers, there is also a driver for each peripheral device you can connect to your Apple III. The driver is provided on a diskette accompanying the device, and is described in the manual supplied with the device.

Complete information on the System Configuration Program can be found in the chapter *The System Configuration Program* in the *Standard Device Drivers Manual*. There you can learn how to

- build a system configuration containing the drivers you need for your particular collection of peripheral devices,
- change a system configuration by adding or deleting device drivers, or
- change the system's standard character set or keyboard layout.

For now, we will just use the System Configuration Program to set up your boot diskettes for the correct number of Disk III floppy disk drives connected to your Apple III. If you have one external drive, your system will already operate correctly. However, you will find it useful to go through the following procedure with one of your diskettes, so that you will understand the procedure.

Using the System Configuration Program

To use the System Configuration Program, boot the Utilities diskette (if you haven't done so already) and choose the option

```
S - System Configuration Program (SCP)
```

from the Main Menu by typing the letter S . After a delay, the Configuration Menu will appear on your screen:

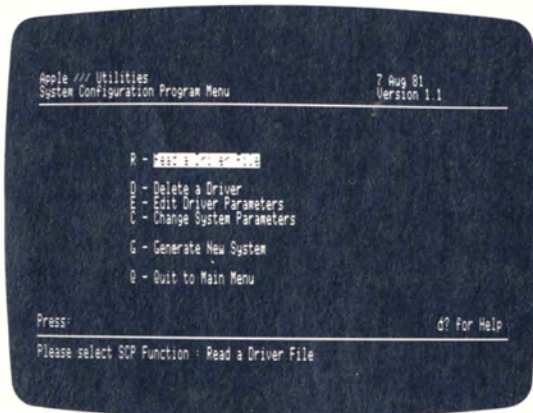

Configuration Menu

At the bottom of the screen is the message

```
Please select SCP Function : Read a Driver File
```

The first step is to read the current system configuration into memory from one of your boot diskettes. Select the option

```
R - Read a Driver File
```

from the Configuration Menu by typing the letter R . A new display

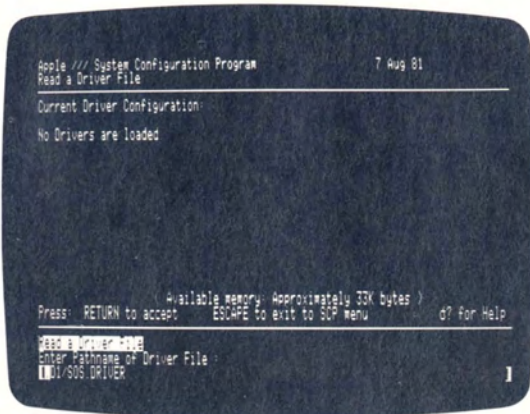

Read a Driver File

will replace the Configuration Menu on your screen. The area near the top of the screen headed

```
Current Driver Configuration:
```

is used by SCP to display a list of the device drivers in the system configuration you are building in the Apple III's memory. Since you haven't yet added any drivers, this area currently contains the message

```
No Drivers are loaded.
```

About halfway down the screen is a line reading

```
( Available memory: Approximately 25K bytes )
```

(The number above will vary with your configuration.)

As you build a system configuration, this line always tells you how much memory space you have left in which to store additional device drivers. The number you see on this line when the configuration is empty depends on the amount of memory you have in your Apple III.

At the bottom of the screen is the message

```
Load a Driver File
Enter Pathname of Driver File :
.D1/SOS.DRIVER
```

The Apple III is waiting for you to supply the name of a disk file containing one or more device drivers.

You are going to load the current system configuration from one of your boot diskettes. You might as well use the Utilities diskette itself, since it is already in your built-in disk drive. The system configuration on a boot diskette is always stored in a file named SOS.DRIVER, so that is the file you should load: type the pathname .D1/SOS.DRIVER and press RETURN.

The disk drive will whirl for a while as the contents of the file are loaded into memory. Then the names of the device drivers contained in the file will appear in a list at the top of the screen, and the program will ask for another filename. (The drivers named .FMTD1, .FMTD2, .FMTD3, and .FMTD4 that you see listed in the Utilities diskette's system configuration are special drivers used for formatting diskettes. The plus signs mean that these four drivers are grouped together into a *driver module*. See READING A DEVICE DRIVER in Chapter 2 of your *Standard Device Drivers Manual* for more information on driver modules.)

Since you don't want to load another file, just press ESCAPE to display the Configuration Menu again.

Changing the System Parameters

Now you are going to look at the system parameters in the system configuration you have just loaded, and change them if necessary to reflect the number of Disk III floppy disk drives connected to your Apple III. Select the option

```
C - Change System Parameters
```

from the Configuration Menu by typing the letter C . A new display replaces the Configuration Menu on your screen. At the top of the screen are the current values of the system parameters, which you have just loaded from the system configuration on your Utilities diskette. At the bottom is the message

```
Change System Parameters
Select Parameter to be Changed :
```

Look at the second line under CURRENT SYSTEM PARAMETERS at the top of the screen. If you are using a brand-new Utilities diskette, or a copy of one, it should read

```
1 - Number of Disk III Drives ..... 2
```

Type the number 1 (the number of the parameter you wish to change). The last line of text on the screen will change to read

```
Select Parameter to be Changed : Number of Disk III Drives
```

Type the number of Disk III drives connected to your Apple III (1, for example, if you have only the Apple III's built-in drive) and press RETURN. You will see the value of the parameter change at the top of the screen, and SCP will again ask you for the number of a parameter you wish to change. For now, just press ESCAPE to return to the Configuration Menu. (System parameters other than the number of disk drives are discussed in the chapter The System Configuration Program in the *Apple III Standard Device Drivers Manual*.) If you have two drives, you can skip this step. We have led you through it so that you will know how.

Generating a New System

Now that you have built a new system configuration in the Apple III's memory, with the correct value for the "Number of Disk III Drives" parameter, you must store this configuration back onto the Utilities diskette. Then the new configuration will take effect the next time you boot the Apple III from that diskette. Choose the option

```
G - Generate New System
```

from the Configuration Menu by typing the letter G . The Configuration Menu will be replaced on your screen by the message

```
System Validation in progress
```

This means that SCP is checking the configuration you've built for internal consistency (it doesn't guarantee that your Apple III will be able to operate in that configuration). If all is well, you will soon see the message

```
--- System Validation Completed ---
```

SCP now asks you for the name of the diskette file in which the new configuration is to be stored:

```
Enter Driver file name :  
D2/SOS.DRIVER
```



In order for the new system configuration to be loaded when you boot the diskette, you must store the configuration into a file named `SOS.DRIVER` . But be careful! If you store a file named `SOS.DRIVER` on one of your important boot diskettes, it will destroy the configuration that was formerly on that diskette. If for any reason the new configuration is not usable, **THAT BOOT DISKETTE WILL NOT BE BOOTABLE** until you recreate a proper configuration and store it onto that diskette.

Don't take chances with your valuable boot diskettes! Whenever you build a new system configuration, store it first onto a *backup copy* of the boot diskette and try booting it. Then, if anything goes wrong with the new configuration, you will still have your original working copy of the boot diskette intact.

SCP is still waiting for the name of a file in which to store the new system configuration you have built. Remove your working copy of

the Utilities diskette from the built-in disk drive and insert the backup copy of the Utilities diskette that you made earlier with the bulk copy utility. Then type

```
.D1/SOS.DRIVER
```

and press RETURN.



Do not leave your working copy in the built-in drive and insert the backup in one of the external drives. *Never* load two diskette volumes with the same volume name at the same time.

When you try to store the new configuration on your backup Utilities diskette, you will get the following prompt:

```
.D1/SOS.DRIVER already exists. Delete? [Y/n]
```

You want to delete the old SOS.DRIVER file and replace it with the new one you have just made, so type Y. If all goes well, the disk drive will whirl for a while as it writes the new system configuration on your backup Utilities diskette. As soon as the operation is completed, you should immediately try booting the diskette.

If the new configuration does not work properly, boot your original Utilities diskette and choose option S (System Configuration Program). From the SCP menu, use option R (Read a Driver File) to load the new configuration from your backup Utilities diskette, and make any necessary changes to the configuration. Generate the new configuration and save it onto the backup diskette, then boot the diskette to see if the new configuration works. If it doesn't, you'll have to boot the original Utilities diskette again and change the configuration so that it works. You shouldn't have this kind of problem, as you are only changing the number of disk drives the system thinks it has: even if you set the wrong number, you should still be able to boot, although you may not be able to use all your drives.

Now load the configuration from another boot diskette, and use the process described above, beginning with the section USING THE SYSTEM CONFIGURATION PROGRAM, to check, modify, verify, and save the new system configuration on your boot diskette. Repeat the process for every boot diskette you have. When you've finished configuring all your boot diskettes, choose option Q (Quit) to return to the main menu.

The System Configuration Program has other capabilities besides the ones discussed here. *The Standard Device Drivers Manual* and the manuals for Apple products that use the System Configuration Program contain instructions on using those capabilities.

The SOS Diskette Request

Now try an experiment. Return to the Configuration Menu, and remove the Utilities diskette from the built-in drive. Now type Q (Quit) and see what happens. You will get a beep, and this message:

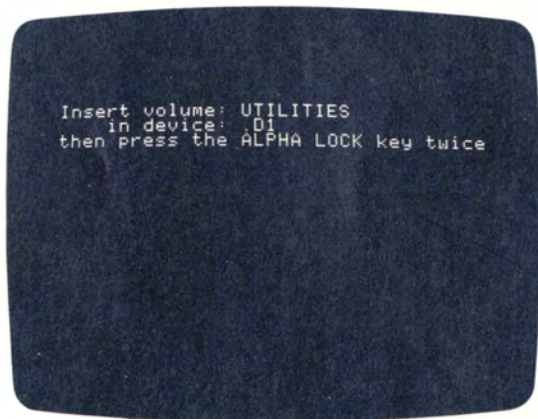

The SOS Diskette Request

After you insert the Utilities diskette and press the ALPHA LOCK key twice, the Main Menu will reappear on the screen. What just happened is this: when you pressed ESCAPE for the second time, the Apple III tried to read part of the Utilities program from the Utilities diskette. When it failed to find the diskette, it asked you to put it in, and waited for you to do so and confirm that you had. Any time SOS

cannot find the diskette it expected to find in a given drive, you will get this message. If the needed diskette had never been in the system, you will not get this message, although you may get a message from the program, telling you to put it in.

The reason that SOS asks you to press the ALPHA LOCK key (rather than RETURN, say) is that ALPHA LOCK does not type a character: so if you had typed ahead, no spurious character would be added to your input.

Formatting Blank Diskettes

Your Apple III comes supplied with some blank floppy diskettes. (You can buy more from your Apple dealer.) You'll use these diskettes to store information and programs you generate while using Apple III languages or applications. But before your Apple III can store any information on a diskette, you must first *format* the diskette.

The Format-a-volume command on the Apple III Utilities diskette invokes the formatting program, which is designed for use with many kinds of mass-storage media, including larger floppies and rigid disks as well as floppy diskettes. So instead of just talking about diskettes, we will use the more general term *volume*, which refers to any form of mass-storage medium.

When a volume of magnetic mass storage (such as a diskette) is manufactured, it contains no information at all: it's like blank recording tape. Formatting the volume prepares it for use by dividing up its recording surface into standard-size *blocks* where information can later be stored.



You can reformat a volume that isn't blank, but reformatting will erase its old contents.

When you format a volume, you also give it a *volume name* by which you can refer to it later. You can choose any name you wish, subject to the rules for local names given under Local Names in the chapter The Operating System. You can also let the formatting program

assign it a unique name, which is handy if you haven't decided what to put on the diskette.

To format a volume, first choose the option

```
D - Device handling commands
```

from the Main Menu by typing the letter D. Then choose the option

```
F - Format a volume
```

from the Device Menu by typing the letter F. You will get this screen:

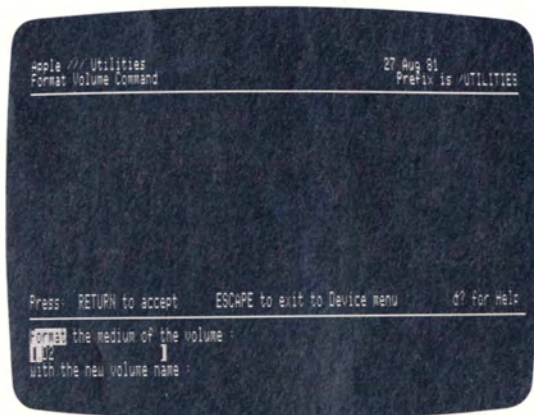

Format a volume

This is a fill-in screen, with two blanks, or *fields*, to fill in. The first,

```
Format the medium of the volume :
102
```

is highlighted (black on white). The first thing you have to tell the formatting program is which device (normally a Disk III floppy-disk drive) you're going to use to format the blank volume. The program has already filled in the field for you, guessing at what you'll type. This guess is called the default, because it will be used by default if you like it. If you press RETURN, the field's contents will be accepted as is; if you type anything, it will replace the default.

If you don't have any additional drives, you'll have to use the Apple III's built-in drive. Its device name is .D1 (for Disk 1). Open the door to the disk drive, remove the Utilities diskette from the drive. Insert the volume you wish to format. Type .D1 and press RETURN.

If you have one or more external disk drives connected to your Apple III, you might want to use one of them, to avoid having to remove the Utilities diskette from the built-in drive. The additional drives are named .D2 , .D3 , and .D4 , for the second, third, and fourth disk drives, respectively.

Storage devices other than floppy diskette drives will have different device names, as specified in the manual accompanying the device. For now, use the first additional drive: insert the diskette into .D2 and press RETURN.

Whichever device you choose, the highlight will move on to the next field



```
with the new volume name : BLANK23 |
```

choosing a random name for it. If you have a name in mind for the diskette, type it and press RETURN.



We strongly recommend that you use a different name for each volume you format. If your Apple III is equipped with one or more external disk drives, it is particularly important *never* to load two volumes with the same name at the same time. Having two volumes with the same name makes it possible for the computer to write information onto one of them in a location where it actually belongs on the other. If this location already contains some other information, the information will be destroyed.

If you wish the formatting program to assign a name, press RETURN without typing anything: the diskette will be given a name from BLANK00 to BLANK99. Each time you run the formatting program, it picks a random starting number for the last two digits of the diskette

name, and numbers further diskettes in sequence from that number; if the numbers go past 99, it starts over with 00. This feature lets you format a whole box of diskettes in a few minutes, without having to worry about calling any of them by the same name.

If the volume you insert is not blank, the formatting program will now ask

```
Is it okay to destroy all the contents of BLANK98? [Y/N]
```

using whatever volume name it finds already stored on the volume. This is a safety feature to prevent you from inadvertently destroying valuable information. If you have inserted the wrong volume or made some other mistake, you can safely cancel the formatting operation, without destroying any information, by typing N (for No). If you really intend to destroy the previous information on the volume you've inserted, type Y (for Yes).



It is very easy to get into the habit of answering Y whenever you see a message like

Do you wish to destroy volume "BLANK23" (Y/N) ?

For this reason, it is wise to use the default names BLANK00 to BLANK99 for blank diskettes, and to rename any diskette that is no longer blank.

After you type Y, the Apple III will make a short rattling sound, then whir and zick for a while as it formats the volume. When it's finished, it will display

```
Format successful
```

Remove the volume from the disk drive, write the volume name you have just given it on the label, place it back in its protective paper envelope, and store it in a safe place. The program is now at the beginning of the formatting sequence so you can format more volumes.



It's a good idea to format all your blank diskettes now and to make sure you always have a supply of formatted diskettes on hand. Suppose you were using some language or application on the Apple III and had entered a lot of information into the computer. If you discovered that all your diskettes were full and could hold no more information, you'd be stuck. You would have no place to save the information stored in the computer's memory, and no way to format a fresh diskette without losing the contents of memory. So every time you get some new, blank diskettes, format them immediately so that they will be ready to use when you need them.

When you have no more volumes to format, press ESCAPE to return to the Device Menu, then go to the next section.



If something goes wrong during the formatting process, the formatting program will display an error message informing you of what went wrong. If you get one of these messages, refer to Appendix A of this Owner's Guide.

We hope that the experience of using both the console demonstration and the Utilities Diskette have made you familiar with the Apple III and the way it works. The next chapter will show you other features of the Utilities diskette.

The Filer

When you formatted and copied diskettes earlier, you used a program called the Filer, on the Utilities Diskette. In that case you performed both operations on input/output devices. More such device operations will be explained later in this chapter. Now you will learn how to do a few things with files. First, boot the Utilities Diskette. With the Main Menu on the screen, type F (File Handling Commands Menu). You will get this menu:

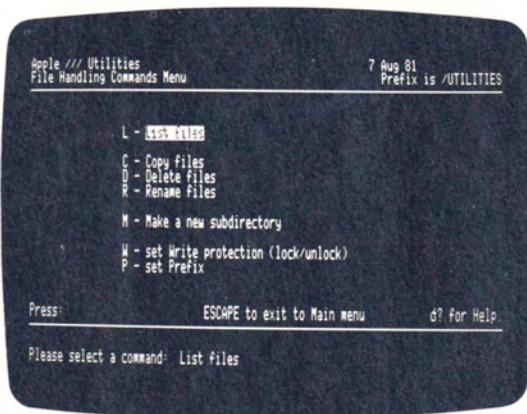

File Menu

The menu lists the operations that the Filer can perform on Files: these will be explained as you read on.

Reading a Directory

With the File Menu on the screen, type L (List files) and respond to the prompt by typing .D1 followed by three RETURNS. Now you will see the Utilities diskette's directory listing (catalog) on the screen. At the top is the volume name of the diskette, followed by a set of headings. Below is a list of the files on the diskette, each followed by some information about it: its size in blocks of 512 characters, the date and time it was last changed, its type, and a few numbers that you don't have to bother with for now. (They will be explained in the *Apple III SOS Reference Manual*.)

Using the Filer

Now let's use some of the commands to make a /PERSONNEL diskette for the Widget Company. First format a diskette, and name it /PERSONNEL. List its directory by typing F L /PERSONNEL (without spaces) and pressing RETURN three times. After the menus and screens go away, you will see this:

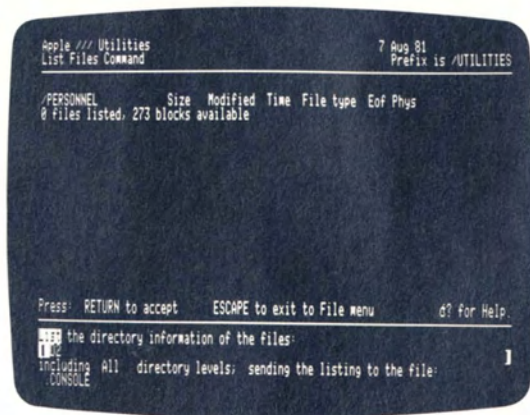

/PERSONNEL directory

Now we're going to make some files. First we need to make some

subdirectories. Get the File Menu up on the screen, and type M (Make). You will see



Make a subdirectory

First you type the pathname of the subdirectory, /PERSONNEL CURRENT, and press RETURN. Now you are asked how many files you need room for in your subdirectory. The default, 25, ought to be enough, so press RETURN. (You can type any number you like: in some cases SOS will allocate more.) When you List the directory of /PERSONNEL, you will have a subdirectory called CURRENT, occupying 2 blocks.

Now create subdirectories named FORMER, COMMUNICATIONS, INTERNAL, and EXTERNAL.

The first column of your directory will look like this:

```

/PERSONNEL
CURRENT
FORMER
COMMUNICATIONS
INTERNAL
EXTERNAL

```

Now we have a problem: INTERNAL and EXTERNAL are subdirectories under COMMUNICATIONS. We can move them where they belong with the Copy command. Type C (Copy) from the File Menu. You will get this screen:

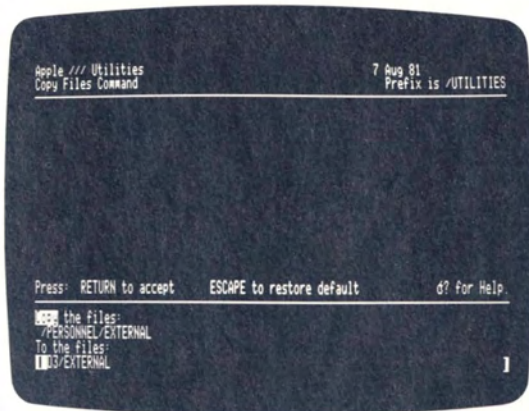

Copy files

If you press RETURN to all the defaults, the Filer will copy the file EXTERNAL from the diskette /PERSONNEL to another diskette. This is not what we want—we want to copy it to a different place on the same diskette, and we want to copy INTERNAL first—so type /PERSONNEL/INTERNAL for the source file pattern (the only file pattern we know about now is a pathname: we will learn about others later in the chapter). Press RETURN. Now type /PERSONNEL/COMMUNICATIONS/INTERNAL for the destination file pattern. Press RETURN. When the whirring stops, list the catalog:

```

/PERSONNEL
  CURRENT
  FORMER
  COMMUNICATIONS
    INTERNAL
  INTERNAL
  EXTERNAL

```

The local name INTERNAL appears in two places: as a subdirectory to /PERSONNEL, and as a subdirectory to the subdirectory COMMUNICATIONS. The indentation of the directory will make this clear: each subdirectory or file is indented under the directory that holds it. We'll get rid of the extra copy in a minute.

Now copy EXTERNAL under COMMUNICATIONS. The source file

pattern is /PERSONNEL/EXTERNAL. The destination file pattern is /PERSONNEL/COMMUNICATIONS/EXTERNAL. Now you will have this catalog:

```

/PERSONNEL
  CURRENT
  FORMER
  COMMUNICATIONS
    INTERNAL
    EXTERNAL
  INTERNAL
  EXTERNAL

```

This is OK, except for the extra copies of INTERNAL and EXTERNAL. We'll get rid of them with the Delete-files command. Type D (Delete) from the File Menu to get this screen:

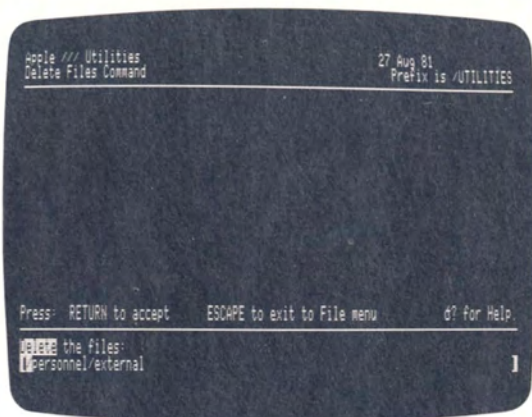

Delete files

Type /PERSONNEL/INTERNAL, then press RETURN. You will be asked to confirm the deletion: type Y (for Yes). After you confirm the deletion, the file /PERSONNEL/INTERNAL will be deleted: that is, removed from the directory it is in. Every operation that could destroy data will require confirmation.

Now Type D (Delete) again, then type the file pattern

/PERSONNEL/EXTERNAL and press RETURN. Confirm the deletion with a Y (Yes). Now list the catalog:

```
/PERSONNEL
  CURRENT
  FORMER
  COMMUNICATIONS
    INTERNAL
    EXTERNAL
```

We could have avoided the deletion, by making the files in the right place in the subdirectory structure, but this roundabout procedure lets us show the Delete-files command.

We now have the skeleton of the Widget company's personnel files. By making a subdirectory /PERSONNEL/COMMUNICATIONS/INTERNAL/ATKINS , we can reproduce the subdirectory structure described in the previous section:

```
/PERSONNEL
  CURRENT
  FORMER
  COMMUNICATIONS
    INTERNAL
      ATKINS
    EXTERNAL
```

We can't reproduce the full hierarchy,

```
/PERSONNEL
  CURRENT
    SIMPSON
  FORMER
    JOHNSON
  COMMUNICATIONS
    INTERNAL
      ATKINS
        MARCH.15
    EXTERNAL
```

because SIMPSON, JOHNSON, and MARCH.15 are not subdirectory files: they are data files, text files, or some other kind of files. The Filer can only make subdirectory files because it cannot produce the contents of other kinds of files. It's like a filing clerk, who can move file folders from drawer to drawer, but doesn't write the letters and memos inside them.

Text-editors create text files, language compilers create code files, accounting programs create data files, and so forth; but the Filer cannot create these kinds of files or change their contents. The Filer is useful for rearranging files created by other programs in forms convenient for you. This will be especially true if you eventually get a mass-storage device larger than a Disk III. Then you will find yourself copying a whole diskette to a subdirectory on the larger device, and moving files from one subdirectory to another on that device.

Operations On Files

In the preceding section, we have tried out a few of the Filer's file-handling commands. In this section, we will examine them all. When you type F (File handling commands) from the Main Menu, you will get this menu:

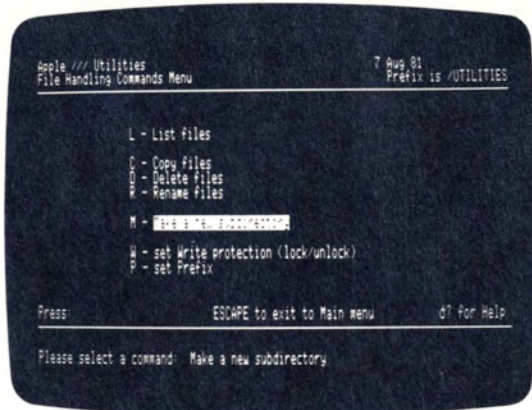

File Menu

You select a command option by typing the letter before it. As soon as you type the letter, the screen for that command appears. You can return to the Main Menu by pressing ESCAPE.



Note that each command option line in the File Menu has one, and only one, capital letter: that is the letter you type to execute that command. In this chapter, every section named for a command will reproduce this spelling quirk faithfully, as an aid to memory and understanding.

List files

The List-files command shows the directory listing (catalog) of a volume or subdirectory. Here is the catalog of the Widget company's /PERSONNEL diskette.

```

Apple /// Utilities                               7 Aug 81
List Files Command                               Prefix is /UTILITIES

/PERSONNEL      Size  Modified  Time  File type  Eof  Plus
CURRENT        27-Aug-81  0:00  Directory  512
FORMER         27-Aug-81  0:00  Directory  512
COMMUNICATIONS 18-Aug-81  0:00  Directory  512
INTERNAL       18-Aug-81  0:00  Directory  512
ATTN          18-Aug-81  0:00  Directory  512
EXTERNAL       18-Aug-81  0:00  Directory  512
6 files listed, 261 blocks available

Press: RETURN to accept   ESCAPE to exit to File menu   d? for Help.

HELP the directory information of the files:
Type:
Including All directory levels; sending the listing to the file:
CONSOLE
  
```

/PERSONNEL Catalog

The volume name appears across the top, followed by headers. Each file is listed on a separate line, its name followed by

Size: the number of blocks taken up by actual data

Modification Date: the date the file was last changed

Time: the time the data was last changed, if time was set

File Type: this can be

Data: binary data

PasText: a file of characters, with certain formatting data

PasCode: a machine-language program file

BASICProg: a BASIC program file

ASCII: a file of characters, without formatting data

Directory: a subdirectory file

Font: a character-set file

Foto: a screen-image file

EOF: the number of characters that can be read from the last block in the file

Physical Size: the number of blocks physically occupied by the file

The relationship between Size, EOF, and Physical Size is fairly complex, and need not concern us here. It is explained in detail in the *SOS Reference Manual*. You will mostly be concerned with the pathname, the size, the modification date, and the file type.

To list the catalog of a directory—either volume or subdirectory—type L (List files) from the File Menu to get this screen:

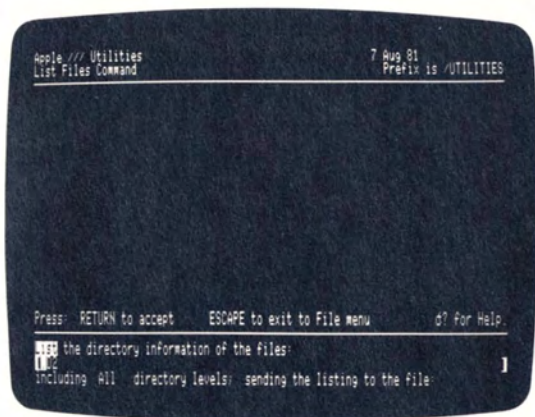

List the catalog entries of files

The screen presents a series of fields to fill in, the topmost field highlighted. Each field is a question you must answer: it contains a default response, which is the program's guess as to your probable answer. If the program guessed correctly, you can accept the default in the highlighted field by pressing RETURN. If not, type the correct response. If you wish to change your response, move the cursor back with the left-arrow key and type over. When you are satisfied, press RETURN to accept the current field's contents and move to the next field. You can back up to the previous field by pressing CONTROL-RETURN.

In the List-files command, the highlight will be on the first field,

```
List the directory information of the files:
```

At this point, you can return to the File Menu by pressing ESCAPE. You may now type a file pattern, described in the next section. In the List-files command, the file pattern is often the pathname of the directory whose files you want to list. The default is the last pathname typed.

The next field asks you how many directory levels you want listed. If you type 1, only the directories and files immediately below the pathname you typed will be listed.

The final field specifies the file to which you want to send the listing. Usually, it's the screen, so you use the default `.CONSOLE`. You can also list to a disk file (like `.D2/LIST.TEXT`) or a Qume (`.PRINTER`) or Silentype (`.SILENTYPE`) printer, if you have one.

While typing into a field, you can change your mind and restore its previous contents by pressing `ESCAPE`.

Once you have filled in the last field as you wish, press `RETURN`, and the catalog will be listed. After the command has been executed, the cursor will hop to the top of the screen: `ESCAPE` will return you to the File Menu. Otherwise, you may execute the command as before: the defaults will now be the values you selected in the previous execution.

Copy files

You have already used the `Copy-files` command to build a subdirectory structure for the Widget company. Now you will learn more about it. To copy a file from one volume or subdirectory to another, type `C` (`Copy`) from the File Menu. You will get this screen:

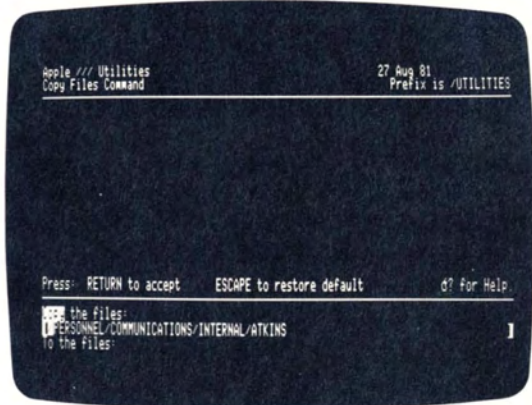

Copy files

The source and destination *file patterns* can be pathnames like /EMPIRE/VADER.DATA or /REBEL/SKYWALKER.DATA . These names each refer to a single file. We have used pathnames before.

A file pattern, however, can be more general: it can refer to a group of files, by the use of a *wildcard*. A wildcard is a character that can stand for any other character or string of characters. For example, the file pattern /EMPIRE/=ADER.DATA would match /EMPIRE/VADER.DATA or /EMPIRE/NADER.DATA or /EMPIRE/MEADER.DATA . It would not match /EMPIRE/MADDER.DATA .

A file pattern can only have a single wildcard, so you could not make a pattern /EMPIRE/=A=H.DATA that would match /EMPIRE/DARTH.DATA and /EMPIRE.RALPH.DATA . In addition, the wildcard can only be in the the last local name in the pathname. For example, /EMPIRE/D=TH.DATA would be valid, but /EM=RE/DARTH.DATA would not.

File patterns are convenient when copying files, as you often have to copy a whole bunch of them at one time. In our earlier example, for instance, we had to do a number of operations to copy the subdirectories INTERNAL and EXTERNAL from the volume directory /PERSONNEL to the subdirectory /PERSONNEL/COMMUNICATIONS : that is, to convert this catalog

```
/PERSONNEL
  CURRENT
  FORMER
  COMMUNICATIONS
  INTERNAL
  EXTERNAL
```

to this one:

```
/PERSONNEL
  CURRENT
  FORMER
  COMMUNICATIONS
    INTERNAL
    EXTERNAL
  INTERNAL
  EXTERNAL
```

With a wildcard, this setup does it in one stroke:

```

Apple /// Utilities                               27 Aug 81
Copy Files Command                               Prefix is /UTILITIES

Press: RETURN to accept   ESCAPE to restore default   d? for Help.

COPY the files:
/personal/fermal
To the files:
/personal/communications/fermal

```

Copy files

A useful option of this command is the ability to copy to a printer or other device, simply by using the device name as the destination file pattern. For example, this screen setup

```

Apple /// Utilities                               27 Aug 81
Copy Files Command                               Prefix is /UTILITIES

Press: RETURN to accept   ESCAPE to restore default   d? for Help.

COPY the files:
/skywalker/memo.txt
To the files:
.printer

```

Copy files

will print the file /SKYWALKER/MEMO.TEXT to .PRINTER . Here we are asked

```
Add a page of directory information before each file? [Yes]
```

Press RETURN to accept the default, Yes : this causes the listing to be printed with a header, consisting of the pathname, the date, and the time of the file printed.

Delete files

To delete files from a volume, type D (Delete) from the File Menu. You will get this screen:

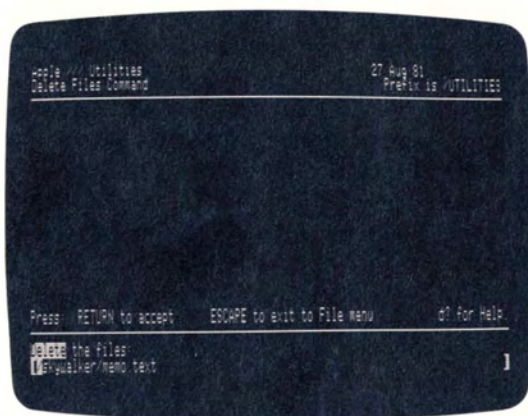

Delete files

When you type a file pattern, the Filer reads the directory specified, and lists the files that will be deleted if you confirm the deletion. If you want to get rid of all of them, type Y (Yes) and they will be permanently deleted; if not, type N (No) and you will have a chance to change the file pattern.

Now try an experiment. With the Delete-files screen up, insert your /PERSONNEL diskette into the built-in drive and type /PERSONNEL/= as the file pattern. Don't press RETURN yet. Instead press the up-arrow. A list of pathnames appears on the right side of the screen, each matching the file pattern. Those filenames ending with a slash (/) are subdirectories. A highlight marks the first pathname in the list. You can move the highlight with the up- and down-arrow keys.

What's the point of these pyrotechnics? Well, you can select pathnames from the list, by moving the highlight to a pathname, then pressing the right-arrow key. An arrow-shaped marker appears by the selected pathname. Similarly, you can deselect a pathname by pressing the left-arrow key, making the marker disappear. When you press RETURN, the list will be culled of all the pathnames not selected, and you will be asked to confirm your selections:

```
Directory /EMPIRE
File TARKIN          deleted
File BOBA.FETT      deleted
Update directory ? [Y/N]
```

If one of the files, say VADER , is a subdirectory containing files, you will be asked for an additional confirmation by a prompt like

```
Directory /EMPIRE
File VADER          deleted
File PLOTS          deleted
File PLANS          deleted
File SCHEMES        deleted
File TARKIN         deleted
Update directory ? [Y/N]
```

Rename files

The Rename-files command changes only the local name of a file, not its contents or its place in the subdirectory structure. Thus, you can rename /EMPIRE/VADER/PLANS.DATA to /EMPIRE/VADER/SCHEMES.DATA , but not to /EMPIRE/TARKIN/PLANS.DATA , as the latter would move the file PLANS.DATA from the subdirectory VADER to the subdirectory TARKIN on the volume /EMPIRE .

To rename a file, type R (Rename files) from the File Menu. You will get this screen;

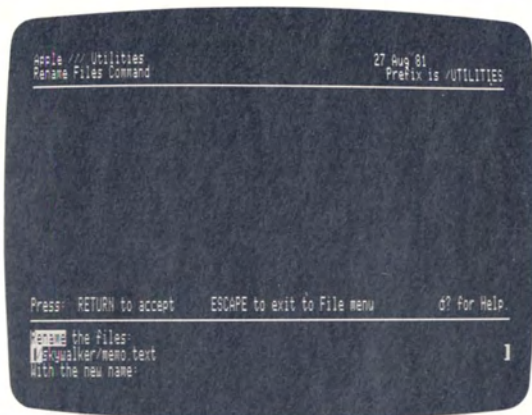

Rename files

After you type the new file pattern, the Filer checks whether (a) anything but the local name is different in the two patterns or (b) any existing files on the volume match the new file pattern. If (a) is true, the Rename-files command is cancelled, leaving the highlight on the new file pattern field, so you can try a new pattern. If (b) is true, you will be asked to confirm that you wish to rename the files matching the old file pattern and delete any existing files that match the new file pattern:



After thinking about it for a while, you may think it's bizarre to use the old file pattern as a default for the new file pattern: why would anyone want to rename a file with its old name? Well, you're right, but it could be useful: if the new pattern were similar to the old one, we could edit the old pattern into the new. But how do we keep the default from disappearing as soon as we start typing? Press the right-arrow key. Now you can move back and forth, replacing any character you want, as if you had just typed them. You can press RETURN to accept the new file pattern, or ESCAPE to restore the default.

Try it: type `/PERSONNEL/COMMUNICATIONS/INTERNAL/ATKINS` into the old file pattern field and press RETURN. The same pathname will appear in the new file pattern field. Press the right-arrow key, until the cursor is on the A of ATKINS . Type SMYTHE . Now press RETURN.

This works fine to change `/PERSONNEL/COMMUNICATIONS/INTERNAL/ATKINS` to `/PERSONNEL/COMMUNICATIONS/INTERNAL/SMYTHE` ; but how do we change it to `/PERSONNEL/COMMUNICATIONS/INTERNAL/BILL.ATKINS` , which has a different length, without retyping a bunch of characters? Try an experiment. Hold down the Open Apple key and type I (Insert). The rectangular “replace” cursor goes away and is replaced by a vertical “insert” cursor, with a blinking underscore beneath it. The replace cursor sat on the character to be replaced; the insert cursor sits between two characters—any character you type will be inserted there.

You can also use the insert cursor to delete characters. If you press the right- or left-arrow key alone, the cursor passes over a character, leaving it unchanged. If you press the right- or left-arrow key while holding down the Open Apple key, the character is swallowed up, never to be seen again. By pressing and releasing the Open Apple key while using the arrow keys, you can hop over a few characters, munch a few, hop a few, munch, hop. . .

By editing the default in this way, you can get the input you want. To accept the input, press RETURN. To restore the default, press ESCAPE.

Make a subdirectory

The Make command creates a subdirectory to put files into. Before you can subdivide files into a subdirectory, that subdirectory, and all the directories above it, must exist. For example, before you can create a file called `/EMPIRE/VADER/PLANS.DATA`, the volume directory `/EMPIRE` and the subdirectory `/EMPIRE/VADER` must have been created. If you try you will get a “Subdirectory not found” error message from SOS.

To create a subdirectory, type M (Make) from the File Menu. You will get this screen:



Make a subdirectory

After you type a pathname and press RETURN, the Filer will check that there is no subdirectory of the same pathname: if there is, it will ask you whether you wish to delete the old one. If you tell it to go ahead, or if your pathname is unique, you will be asked how many files it needs to hold. Usually the default is enough: if so, press RETURN; if not, type a number. SOS may allocate more. If you want to add more files later, you will have to make a new subdirectory with a different name, then copy the files into it, delete the old subdirectory, and rename the new one.

set Write protection

Many diskettes have silver-colored write-protect tabs to keep the computer from writing on them. Well, you can also protect a file in a similar way, using the set-Write-protection command. Each file has a write-protect flag, which tells the computer whether the file can be written to (or deleted), or not. When the flag is set, the file is locked: you can read the file, and nothing else. When the flag is cleared, the file is unlocked: you can read, write to, or delete the file. If you have tried to delete (or copy over) a file and gotten a "Write protect error" message from SOS, this command will let you go ahead.

To change a file's write-protect flag, type W (set Write protection) from the File Menu. You will get this screen.

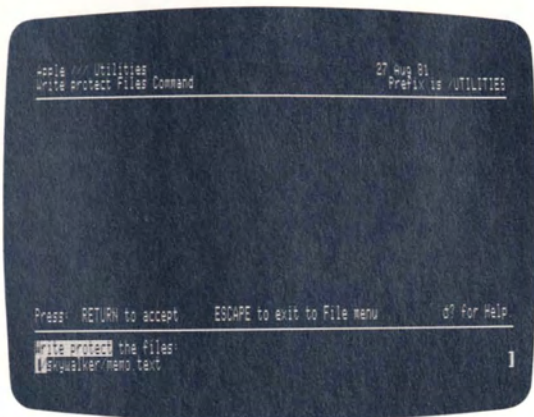

set Write protection

After typing the file pattern and pressing RETURN, type Y (Yes) or N (No) to lock or unlock the file.

set Prefix

The set-Prefix command sets the SOS prefix, which is appended to partial pathnames not starting with a slash (/) or period. For example, if the prefix is /PERSONNEL , when you type COMMUNICATIONS in response to a file pattern request you will get /PERSONNEL/COMMUNICATIONS . If you type /COMMUNICATIONS/INTERNAL/ATKINS/MAR.15.TEXT , the prefix will not be added. To set the prefix, type P (set Prefix) from the File Menu. You will get this screen:



set Prefix

An interesting use of a prefix is this: we have a large disk, called /WIDGET . On this disk we wish to make an "image" of the diskette /PERSONNEL : that is, a reproduction of its entire subdirectory structure. First we set the prefix to /WIDGET :

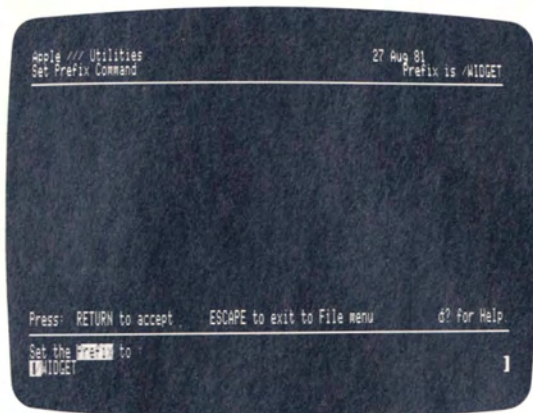

set Prefix

After pressing RETURN, we then type C to bring up the Copy screen, and type the following inputs:

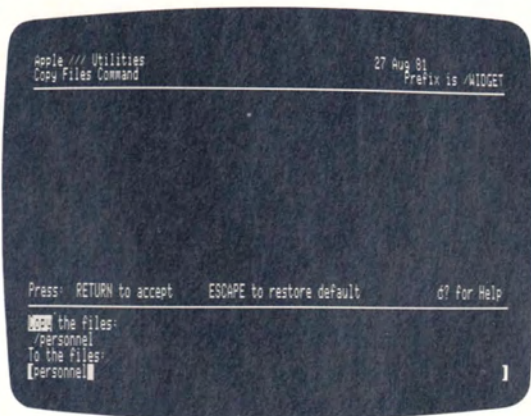

Copy files

This command will copy the volume directory /PERSONNEL and all of its subordinate files to the subdirectory PERSONNEL on the volume /WIDGET . Here is an outline of the directory for /WIDGET :

```

/WIDGET
  ACCOUNTING
    PAYABLE
    RECEIVABLE
  INVENTORY
  PERSONNEL
    CURRENT
    SIMPSON
  FORMER
    JOHNSON
  COMMUNICATIONS
    INTERNAL
    ATKINS
    MARCH.15
  EXTERNAL
  
```

As you can see, the directory structure under the subdirectory PERSONNEL on the large disk /WIDGET looks like the directory structure of the volume directory of the diskette /PERSONNEL .

Operations On Devices

The Utilities Diskette has a number of commands that operate on input/output devices. Some of them work only on block devices, like disk drives, that store data: you can copy one volume to another, rename a volume, format a volume to hold data, or verify that a volume is readable. Other commands operate on all devices: you can list the devices the operating system knows about, or set the system's time and date.

In the case of floppy-disk drives, the volume name is that of the diskette (a diskette is always a single volume), and the name follows it as it migrates from drive to drive. In the case of other block devices, the relationship between volumes and devices may vary, but this remains constant: the device name never changes, and always refers to the whole device. Since we will only discuss (Disk III) floppy-disk drives in this manual, you can assume that a diskette's volume name and its drive's device name can be used interchangeably as long as the diskette remains in that drive.

All the commands discussed in this section operate on an entire device. Other commands, which operate on files, were discussed in the previous section, "Operations on Files".

To use any of the device commands, boot the Utilities Diskette (if necessary) and select option D (Device handling commands) from the Main Menu. This will get you the following menu:

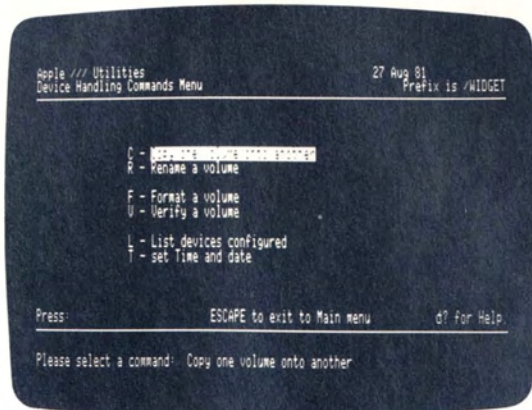

Device Menu

Typing any of the letters in the left column will get you the screen for the command it stands for. You can also use the up-and down-arrows to move the selection, and press RETURN to accept a selection. Copy-volume is the default: if you press RETURN without typing anything, you will get the Copy-volume screen. To return to the Main Menu, press the ESCAPE key.

Copy one volume onto another

You have already used the Copy command to make a backup of your Utilities Diskette. This command replicates the contents of one device or volume on another device or volume with the same number of blocks: for example, from one Disk III to another.

For example, you could copy .D1 to .D2 ; or you could copy /SKYWALKER in .D1 to /VADER in .D1 , if you had a one-drive system (you would have to do some diskette-swapping). You could not copy a Disk III's contents to a disk drive of different capacity or format, such as a hard disk. For this you would have to use the Copy files command, described in the section Operations on Files, preceding.

When you type C (Copy one volume onto another) from the Device Menu you get this screen

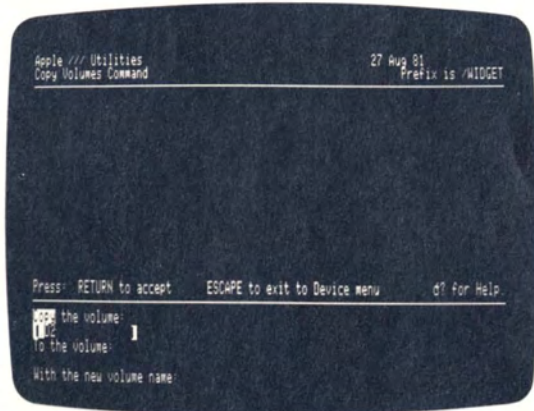

Copy one volume onto another

with a series of fields to fill in, the topmost field highlighted. Each field is a question you must answer; it contains a default response, which is the program's guess as to your most probable answer. The ones displayed above are for a 2-drive system. If the program guessed correctly, you can accept the default in the highlighted field by pressing RETURN. If not, type the correct response. If you wish to change your response, move the cursor back with the left-arrow key and type over. When you are satisfied, press RETURN to accept the current field's contents and move to the next field. You can back up to the previous field by pressing CTRL-RETURN.

First you specify the source volume by typing the device name of the drive, or the volume name of the diskette, you wish to copy from; then insert the source volume into the appropriate drive and press RETURN.

Then the copy program will try to read the source volume's directory. If it doesn't find a directory, or you typed a volume name that cannot be found, it will ask you to insert the proper volume.

Next you specify the destination volume by typing the name of the drive or diskette you wish to copy to; then insert the destination volume into the appropriate drive and press RETURN.



It is a good idea to put a write-protect tab on a diskette you wish to copy from. This way, if you specify the source and destination volumes incorrectly—say, if someone interrupts you to ask a question—you will get an error message rather than erasing the wrong diskette. You didn't need to do this with the Utilities diskette, because the original is write-protected: it doesn't have a notch on its right side.

The next field asks you for the volume name you wish the copy volume to have: this allows you to make two diskettes with the same

contents and different names. Type the new destination volume name, if different from the source. If you have made any mistakes, you can back up and change any field you want by using CONTROL-RETURNS. When you are satisfied, accept the destination volume name by pressing RETURN to go ahead with the copy.



When making a 1-drive copy, it is advisable to use the diskettes' volume names, not the device name. This way, you can be sure that you and the system agree on which diskette is the source and which is the destination.

Then the copy program will try to read the destination volume's directory. If it finds a directory and any files on the volume, you will be asked something like

```
Destroy old /VADER ? [Yes]
```

If you reply Y (Yes), the destination volume will be reformatted and the source volume will be copied onto the destination volume. The previous contents of /VADER, and its very name, will be obliterated. If you reply N (No), you will return to the Copy screen.

If you are doing a 1-drive copy, you will need to swap diskettes several times before you are finished: each time, the program will prompt you to insert the proper diskette, and will check its name after you insert it.

If you interrupt the copy process, the source volume will be unaffected, but the destination volume will be unusable. If this happens, simply start the copy process over again.

You can repeat the copy process as many times as you like without retyping any of the fields: simply put in the next destination diskette and press RETURN to accept each field as currently specified. To return to the Device Menu, press ESCAPE.

Rename a volume

This command lets you change the name of a volume, without changing its contents. If you type R (Rename a volume) from the Device Menu (with the volume to be renamed connected to the system), you will get the following screen:

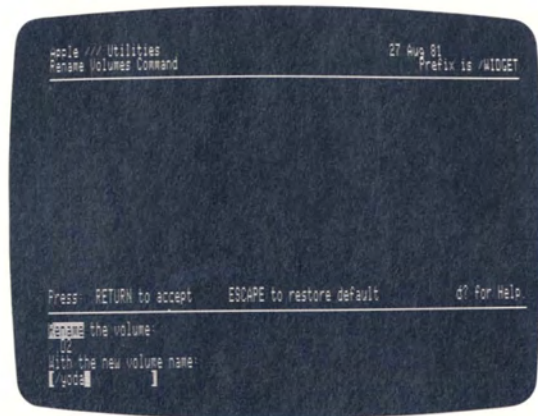

Rename a volume

As with the Copy-volume command, you can use the default or type your own volume or device name (as long as you don't try to rename the boot volume), then move on to the next field by pressing RETURN. Now type the new volume name, or edit the default. The new volume name must not match the name of any volume connected to the system. When both fields are the way you want them, press RETURN.

Format a volume

The Format command prepares a volume, such as a diskette, to hold data by dividing it into tracks and sectors of uniform size and writing a directory on it. The same Format command works on any block device configured into your system.

If you type F (Format a volume) from the Device Menu, you will get the following screen:

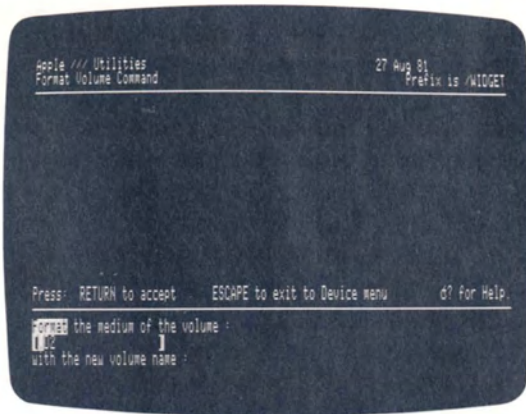

Format a volume

As with the Copy-volume command, you can use the defaults or fill in your own names. The default for the volume name will be a name from BLANK00 to BLANK99, assigned randomly by the formatting program. If you format a bunch of volumes in a row, they will be numbered in series from the first random number. This changing default makes it easy to make sure your volumes have unique names.

When you are satisfied, press RETURN. The program will try to read the directory of the destination volume. If there is one, you will get a message like

```
Is it okay to destroy all the contents of VADER? [Y/N]
```

An answer of Y (Yes) will cause the volume to be reformatted. An answer of N (No) will leave you at the top of the Format screen.

By pressing ESCAPE, you can go back to the Device Menu.

Verify a volume

Sometimes you may suspect that a volume has been damaged or its data has been scrambled. To check the volume, use the Verify command, which checks each block for evidence of errors. Each block of a volume has a number, called a checksum, that is derived from the contents of the block, and changes any time the contents are changed. The Verify command computes the checksum each block should have, and compares it with the checksum it does have: if they match, the block is OK; if not, it is faulty. To find any bad blocks on a volume, type V (Verify) from the Device Menu. You will get this screen:

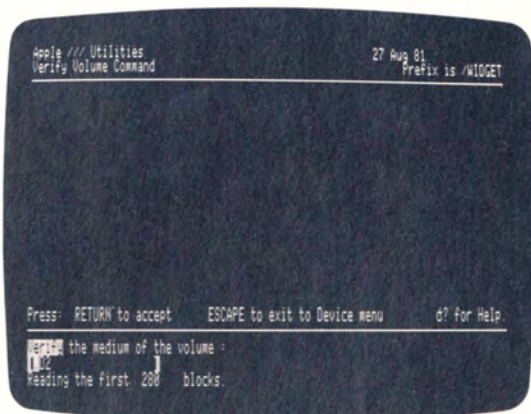

Verify a volume

First you specify the volume to be verified, using the default if it fits, and press RETURN. Then you specify the number of blocks to be checked: usually you will want all of them, which is the default. If the volume has no directory, there will be no default number of blocks. When you press RETURN, the volume will be verified. If it is OK, you will get this message:

```
0 bad block(s)
```

If the volume is not OK, you will a message like this:

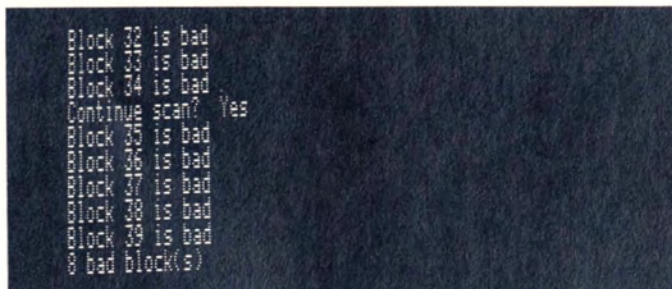

If you have any bad blocks, it is a good idea to copy all the intact files (those not endangered) to another volume, using the Copy File option on the File Menu. Using the Copy Volume option on the Device Menu will copy the error, as well as the intact files.

List devices configured into system

This command lists the devices and volumes configured into your system. If you type L (List) from the Device Menu, you will get a list of all devices the operating system can communicate with, like this:

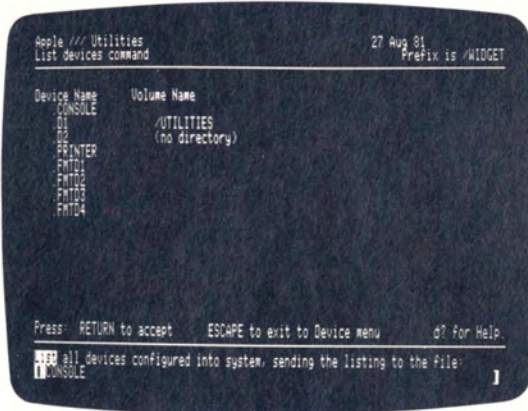

List devices configured into system

The list shows the device name of each device and the volume name, if any, of each block device. An empty disk drive will, not surprisingly, have no volume name.

set Time and date

Every time you store information on a volume, the file containing the information is marked with a date and time; every time the file's contents are changed, the date and time are updated. The date and time are stored on the Utilities Diskette. To change the date and time, use the set-Time command. From the Device Menu, type T (set Time) and press Return. You will get a display like this:

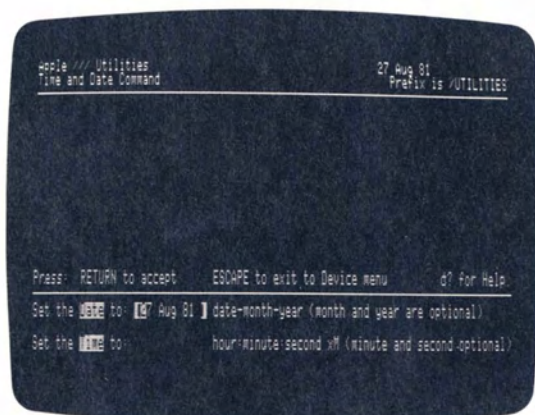

set Time and date

If you want to keep the same date, press RETURN. If you want to change the date, you type the day first, then the month, then the year, all separated by hyphens. (You can use the arrow keys to avoid retyping the defaults). The day must be a number. The month must be the first three letters of the month's name. The year must be a 2-digit number. If we are still making Apple III's in 2001, we'll revise SOS to handle the new dates. When you have the date you want, press RETURN to set the time.

If you want to keep the same time, press RETURN. If you want to change the time, type the hour, minute, and second, separated by colons. (You can use the arrows as above.) When you have the time you want, press RETURN.

Utilities Diskette Selection and Editing

Menu Selection

You may select an option from a menu in one of two ways. You can either type the letter or digits displayed to the left of your chosen option—remember to press the RETURN key if the message “Press RETURN to accept” is present on the screen. Or, if you prefer, you may use the up- and down-arrow keys to move through the menu, and press the RETURN key when you have reached the correct item.

Editing Input Fields

When the Utility program (which includes the Filer and the SCP) requests information, it displays a prompt telling you what it needs and a highlighted field with the cursor inside. Frequently, a default response will appear in the field. You may respond in several ways.

If you wish to return to the previous menu, press the ESCAPE key as the first character of your response. If you wish to return to the previous field on the screen, press the RETURN key while holding down the CONTROL key. If the default response is correct, press the RETURN key to accept it. If the guess is incorrect, type the correct information, and then press the RETURN key when you are finished.

The Utility program provides some features for editing the contents of input fields. They are invoked by special keys or key combinations.

While typing information, you can use the left- and right-arrow keys to move the cursor back and forth within the field to correct typing mistakes. When the cursor is located on incorrect characters, type in the correct characters. When you have corrected your mistakes, press the RETURN key to accept the contents of the whole field as displayed. If you do not want to accept all of the characters in the field, you must delete all those you don't want.

If you decide there is a character in the field that doesn't belong there, you can delete it. Move the cursor on top of the offending character, then press the right-arrow key while holding down the

Open Apple key. This deletes the character under the cursor from the field and moves the remaining characters one to the left. You can also delete characters to the left of the cursor by pressing the left-arrow key while holding down the Open Apple key.

To add characters to a field, move the cursor to the point where you want to insert, and press the I key while holding down the Open Apple key. This puts you in *insert mode*, and all characters you type are inserted between two characters already in the field. Notice that the cursor indicates insert mode by switching to a vertical bar between two characters (with a blinking underline line to help you find it). You leave insert mode the same way you enter it: by typing I while holding down the Open Apple key. You can also move and delete characters in insert mode by using the left- and right-arrow keys.

If the default response provided is nearly correct, you can edit it. If you begin to type your own response, the default will disappear. But if the first key you press is an arrow key or Open Apple key, the default will not disappear, and you can modify it until it is what you want.

If you are editing the characters within a field, and decide you would like to restore the characters in the field to the default response, press the ESCAPE key. You now have the same options as you did upon entering the field. If you wish to return to the parent menu, press the ESCAPE key again.

Pathname Selection

Certain fields request that you provide one or more pathnames of files or devices. In addition to the capabilities described above, the following additional editing features are available. While you are typing a pathname, you can display a directory containing all the files that match the pathname. After looking through this directory, you can select a subset for use, or select one pathname to enter into the field.

File patterns: To specify a group of files in a directory, you use a file pattern. A file pattern is a pathname with a wildcard in the local name. The wildcard character is the equal sign (=). A file pattern containing a wildcard describes all files whose name matches the file

pattern with the wildcard replaced by appropriate characters. For example, if the directory /EMPIRE contains the files

```
VADER.DATA
NADER.DATA
MEADER.DATA
MADDER.DATA
```

then /EMPIRE/=ADER.DATA describes the first three.

Entering pathname menu: Type a file pattern, then press the up- or down-arrow key. A menu now appears on the screen of all the files that match that pattern. If no wildcard appears in the field, then one will be added at the end to display all files in the directory specified whose local names start with the characters typed.

Moving: The first file in the list will be highlighted. You can move the highlight up or down the list with the up- or down-arrow keys.

Selection: Select a file in the list by typing a right-arrow. A right-arrow will appear on the screen pointing to the files to remind you which have been selected. If a command in the filer expects a group of files, you may select more than one.

Deselection: To change your mind and deselect a file, move the highlight to the file and type a left-arrow.

Acceptance: Type an ENTER to continue editing the string you were typing. If you selected exactly one file, its name will enter into the field. If the selected file is a subdirectory (indicated by slash to the right of the file name in the selection list), you may add characters and type an up- or down-arrow again to select from the files in that subdirectory. You may then use any of the selection commands outlined above. If you have selected a group of files and you type an up- or down-arrow again, you may further narrow down the subgroup. Type a RETURN to accept the whole field. (ENTER RETURN is equivalent to just a RETURN).

Summary of Editing Features

RETURN	Accepts the contents of the field. Moves the cursor to the next field on the screen. If the cursor is within the last field on the screen, the command is executed.
CONTROL-RETURN	Moves the cursor to the previous field on the screen.
ESCAPE	As the first keypress in response to a default response: Returns to the parent menu. As any other keypress in a field: Restores the default response.
Left-arrow	Moves the cursor one character to the left.
Right-arrow	Moves the cursor one character to the right.
Open-Apple-I	Turns insert mode on and off.
Open-Apple-Left-arrow	Deletes the character immediately left of the cursor.
Open-Apple-Right-arrow	Normally deletes the character under the cursor. Deletes the character immediately right of the cursor in insert mode.

Summary of Pathname-Selection Keys

=	Wildcard character. In pathname, may be replaced by any characters to match local names on the volume.
Up-arrow	In field editing of a pathname: Enter file selection mode. In file-selection mode: Move highlight up one pathname.
Down-arrow	In field editing of a pathname: Enter file-selection mode. In file-selection mode: Move highlight down one pathname.
Right-arrow	In file-selection mode: Select the highlighted pathname.
Left-arrow	In file-selection mode: Deselect the highlighted pathname.
ENTER	Accept the group of selected pathnames and return to field editing.
RETURN	Accept the group of selected pathnames and accept the field. (This is the same as ENTER followed by RETURN.)

The Machine

The Front

Two things are prominent on the front of your Apple III: the typewriter-like keyboard and the slot for the disk drive.

The Keyboard

The Apple III keyboard has two sections: the 61-key main keyboard and the 13-key numeric keypad.

The main keyboard has letters, numbers, and special symbols in traditional typewriter layout. All ASCII characters are included. The CONTROL, SHIFT, and ALPHA LOCK keys are used to modify the character codes produced by the other keys. The two Apple keys (Open Apple and Closed Apple, to the left of the spacebar) can also be used to modify the meaning of the characters.

The RETURN, ESCAPE, TAB, ENTER, and four directional arrow keys produce control characters. Control characters are used in various ways by different programs.

If you hold down any key (except CONTROL, SHIFT, ALPHA LOCK, or the Apple keys) for more than one half second, it will repeat automatically at a rate of 11 characters per second. If you press and hold down the Closed Apple key while pressing another key, that key will repeat at a rate of 33 characters per second. Each of the four directional arrow keys has three positions: unpressed; pressed so that it clicks once, the 11-characters-per-second position; and, pressed harder so that it clicks again, the 33-characters-per-second position.

The thirteen keys on the numeric keypad generate the same characters as their main keyboard counterparts. They are grouped here to make entry of numbers easier, as on an adding machine. Even though the keys on the numeric keypad generate the same ASCII codes as their counterparts on the main keyboard, a program can detect whether a pressed key is on the numeric keypad or on the main keyboard.

The ENTER key on the numeric keypad is the same as the RETURN key on the main keyboard.

The Disk Drive

The other prominent feature on the face of the Apple III is the access slot for the built-in disk drive. To insert or remove a diskette, you must first open the disk drive door by pulling up on its bottom edge.

You should insert a diskette into the drive with its label upwards and its oval slot pointing into the drive. The built-in disk drive is slightly lower in back than it is in front; you should point diskettes slightly downwards when you insert them into the Apple III. Make sure when you are inserting a diskette that you push it in all the way: if the diskette is not completely inserted, you cannot close the door.

The Apple III can read from or write to a diskette only when the diskette is fully in the drive and the door is closed. When the Apple III is using the disk drive, the red light under the drive door will come on. This is an indication that the diskette is spinning and that the Apple III is reading from or writing to the diskette.



When the IN USE light is on, you should not open the drive door or turn the Apple III off. Either of these actions could cause the head to write un-readable information on the diskette.

Sometimes a disk drive makes a loud raspy noise, as if it's clearing its throat. This happens when the disk drive door is open, during the formatting process, and at various other times. The noise is caused when the disk head is being set for accuracy; it is nothing to worry about.

Installing External Devices

Many devices will plug directly into the back of the Apple III, as the video monitor does. Apple Disk III drives plug into the slot marked "FLOPPY DISKS"; the QUME letter-quality printer connects to the plug marked "PORT C" on the back of the Apple III; Cursor III joysticks plug into "PORT A" or "PORT B"; and the Silentyper printer plugs into "PORT A".

Other devices attach to *peripheral interface cards*, which you install inside the Apple III. Read the manual accompanying each device to see how it should be installed, or get your dealer to help you.

*** IMPORTANT ***

Before connecting or disconnecting
ANYTHING
on the Apple III,
TURN OFF THE POWER.
This is a *MUST*.

Instructions for installing Disk III Drives are given in a previous chapter. To install other devices that plug into the back of the Apple III, see the following section, "The Back". For devices that must be installed inside the Apple III, see the section "Inside the Apple III", also in this chapter.

Many devices, especially those installed inside the Apple III, will be supplied with a diskette containing programs to operate that device. These programs, called *device drivers*, must be installed in your Apple III diskettes just as the hardware is installed in your Apple III. The Apple III *Standard Device Drivers Manual*, which accompanies this manual, describes how to install these programs.

The Back

The back and most of the case of the Apple III is made of cast aluminum, with vertical fins along the back and part of the sides. These fins dissipate heat generated by the circuitry of the computer, in much the same way as the fins on a radiator or engine cylinder. Thus the Apple III does not need a fan to cool itself. The fins and the aluminum part of the case get warm while the Apple III is operating; this is a normal condition.

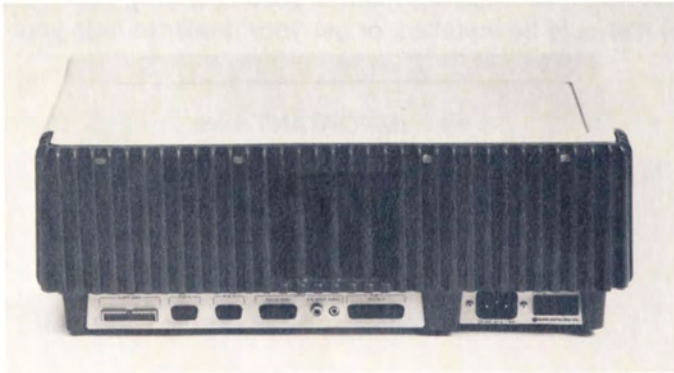

The Back of the Apple III



The Apple III must be placed on a firm surface so that air can circulate freely about it. An Apple III placed on a deep pile carpet will become too hot, and may shut itself off until it has cooled down.

Most devices you use with your Apple III plug directly into one of the ports on the back panel of the computer. The back of the Apple III also has four large, vertical access slots that hold connectors for peripheral interface cards (these are discussed in the next section, "Inside the Apple III").

*** WARNING! ***

Before connecting or disconnecting
ANYTHING
on your Apple III,
TURN OFF THE POWER SWITCH.
This is a *MUST*.

The Power Switch and Connector

On the right side of the back of your Apple III (looking from the rear) are the power connector and power switch. The Apple III accepts power-line input in the range of 107 to 132 volts, 60 Hertz alternating current. The connector has three prongs: two for line voltage, and one for earth ground.

The power switch is located next to the power connector. The switch has two positions: ON (labeled "ON" or "1") and OFF (labeled "OFF" or "0"). When the power to the Apple III is on, the power-on indicator on the keyboard (to the left of the spacebar) lights up with the word ON.

The Disk Drive Connector

The leftmost connector (looking from the rear) on the back of the Apple III, marked FLOPPY DISKS, enables you to connect up to three additional Apple Disk III drives to your Apple III. The first additional drive plugs into the Apple III. The second additional drive plugs into the first, and the third plugs into the second. This connection scheme is called a "daisy chain".



You should never connect more than three external disk drives to the FLOPPY DISKS connector of the Apple III. Also, the disk drive connector is meant to connect only to Apple Computer's Disk III drives. **DO NOT CONNECT ANY OTHER PRODUCTS OR PERIPHERALS TO THIS CONNECTOR:** you may damage both the peripheral and your Apple III.

If you want to connect a hard disk to your Apple III, you may still have up to three Apple Disk III drives. Hard disks are connected through the slots inside the Apple III's case, and are controlled separately from the floppy disks.



Before you can use a second or third external drive, you must configure the system to recognize it, as explained in the chapter on the Utilities Diskette.

The Joystick Ports

Next to the disk drive connector are two nine-pin D-type connectors that allow you to connect miscellaneous input and output devices to your Apple III. Each connector provides access to one joystick port. The most common use for these ports is to connect to Apple Cursor III joysticks.

(A joystick is an input device that resembles the control stick of an airplane. The stick moves in two dimensions: forward-backward and left-right. Apple III programs can use inputs from a joystick to move things around on the screen.)

Each port has circuitry for the X- and Y-axis joystick inputs, and for a pushbutton and a switch input. Electrical specifications for these ports are given in Appendix C.

The Silentype Printer Port

In addition to its function as a joystick port, port A on the back of your Apple III can also be connected to an Apple Silentype printer. Details of the connection, setup, and operation of the Silentype are given in the manual accompanying the Silentype.

The Color Video Port

If you wish to connect your Apple III to some display device other than the standard black and white monitor, you may need to use the COLOR VIDEO port located to the right of ports A and B. This 15-pin D-type connector carries National Television Standards Committee

(NTSC) compatible, positive composite synchronization, color and black and white video signals. The port also carries composite synchronization signals and other signals that can create Red, Green, and Blue (RGB) color video output, as well as all four power supply voltages.

The signals available on this port allow you to connect your Apple III to any color or black-and-white video monitor, an RGB studio quality monitor, a video tape recorder, or any other video device. For full details of the signals available on this port, please see Appendix C.

The B/W Video Port

The round connector immediately to the right of the color video connector, marked B/W VIDEO, carries only the black and white, positive composite synchronization video signal. This connector is an RCA-type female phono jack and will connect to any male RCA-type phono plug. A cable with such a plug is included with your Apple III.

Physical specifications of this jack and electrical specifications of its port can be found in Appendix C.

The Audio Port

Any sound generated by the Apple III's speaker can be captured and sent to an external speaker, tape recorder, amplifier, or other device by connecting that device to the AUDIO jack on the back of the Apple III. When you insert a miniature phone-tip plug into this jack, the Apple III's internal speaker is silenced; if there is an amplifier or other device properly connected to the plug, then that device will receive all audio signals generated by the Apple III.

Physical and electrical specifications of this jack can be found in Appendix C.

The Serial Port

Port C lets you connect the Apple III to all devices that use the RS-232-C standard communication format. This includes letter-quality printers, high-speed-data collection devices, other computers,

modems, and many other devices. The RS-232-C protocol was specified by the Electrical Industries Association (EIA).

The electrical specifications for this port are given in Appendix C.

Inside the Apple III

The inside of your Apple III contains the most important parts of the computer. You need to see the inside of your Apple III only when you are installing or removing interface cards for peripheral devices, or using the security mount to attach the Apple III to a table or shelf to prevent theft.



Before removing the cover of your Apple III, or connecting or disconnecting anything on the inside or outside, **TURN OFF THE POWER SWITCH.**

Removing the Cover

The cover is attached to the case of the Apple III by two quarter-turn screws located on the base, under the lower left and lower right corners of the face of the Apple III:

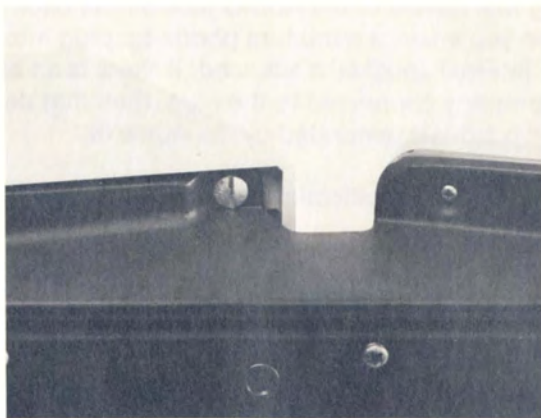

Cover Attachment Screw Locations

After turning the power off, use a short, flat-blade screwdriver to turn both of these screws one-quarter turn in either direction. If you don't have a screwdriver short enough, remove all the connections from the back of the Apple III and tilt it up onto its backside to loosen the screws. They should loosen and fall down (they're captive screws and won't fall out of the case). Remove the cover by lifting it straight up.



Because of electromagnetic-interference regulations, the United States Federal Communications Commission (FCC) prohibits the operation of an Apple III with its cover removed. To remind you of this, when you open the cover of your Apple III, there is a small red light on the left side of the main board, near the back. If you see that this light is on, **TURN YOUR APPLE III OFF!** (Don't forget to save any programs or data you might be working on.) This light is intended to protect your Apple III by reminding you that the power is still on. You should not remove the cover of the Apple III or connect or disconnect anything while the power is on.

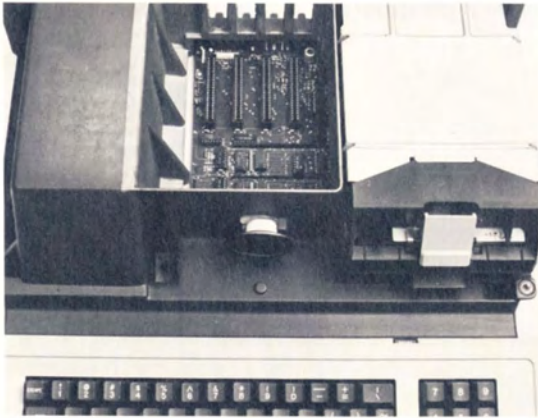

The Inside of the Apple III

Peripheral Device Cards

On the inside of the Apple III, between the disk drive and the power supply, is a rectangular well. At the bottom of this well are four long

connector sockets, mounted on the main board. These connector sockets, called *peripheral connectors* or slots, are meant to hold Apple III peripheral interface cards. With these slots, you can connect your Apple III to many devices that cannot be plugged into an Apple III port or connector.

The four peripheral slots are numbered from 1 to 4, counting from left to right, as viewed from the front of the machine. Peripheral interface cards can usually be placed in any of the four slots; to find out the particular slot into which a given interface card should be installed, consult the manual accompanying that card.

As a precaution, some Apple III's were shipped with dummy cards inserted into their slots. The sole purpose of these cards is to hold the metal shields that cover the four vertical access slots in the back of the Apple III's case. These shields prevent excessive radio-frequency interference (RFI) from leaking from the Apple III. This was later deemed unnecessary and the shipment of the dummy cards was discontinued. Apple III interface cards have similar shields, some of which may have plugs, connectors, or switches mounted on them. If your Apple III has dummy cards, then you must remove one each time you wish to install a peripheral card into a slot.

Removing Peripheral Cards

Peripheral interface cards are supported on the bottom by the peripheral slots, on the back by their metal shields, and on the front by notches in the front of the well. These notches are called “card guides”.

To remove a peripheral interface card (or a dummy card), you should pull straight up on it. To assist you, there is a hole drilled in the top of each card, near the back of the card. You can use a hook in this hole to pull the card straight up, or you can gently pry the card up with a screwdriver, using the side of the well for leverage.

Pull the card straight up and out of the well. The shield, which fits into one of the tall vertical access slots in the back of the Apple III, may be tight: you may have to push it up with your forefinger to remove the card.



Removing a Peripheral Card



Handle any peripheral interface card as you would handle a high-quality, expensive phonograph record. Grasp it only by the corners or edges, and try not to touch the delicate components or pins. Don't grasp the card by the gold or silver contact “fingers”: they are the way the Apple III communicates with the card, and their efficiency is decreased if they are dirty or scratched. Interface cards are precision instruments

and should be handled with care. Store unused interface cards in the boxes in which they were shipped.

Installing Peripheral Cards

To install a peripheral interface card in your Apple III, first see the manual accompanying the card to determine which slot the card belongs in. Then, if there is a dummy card in that slot, remove it (see above).

With the Apple III facing you, and the cover (and the power) off, hold the card with the silver or gold "fingers" pointing down into the Apple III. The components should be on the right side of the board. Slide the near edge of the card into the card guide and the metal shield into the access slot, like this:



Installing a Peripheral Card

Slide the card evenly down until the "fingers" enter the peripheral connector itself. At this point, the metal shield should be tightening up in the access slot. Now you're going to have to use just a little force (not too much) to fit the card completely into its slot. You can tell that the card is fully inserted when the top of the metal shield is flush with the top edge of the access slot.

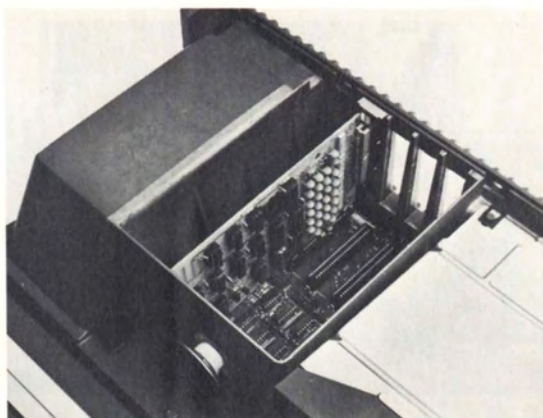

A Fully Inserted Peripheral Card

If the peripheral card doesn't seem to fit, remove it completely and try again, making sure that the card enters the card guide straight up and down.

The Speaker

The Apple III's internal speaker is mounted on the front of the face of the Apple III, right inside the top cover. The speaker is mounted facing the front of the computer, and is connected to the main board by a long twisted pair of wires. The sounds generated by the speaker can be controlled by your programs, but the volume of the speaker cannot be adjusted. The speaker can be silenced by inserting a miniature phono plug in the AUDIO jack in the back of the Apple III (see the previous section).

The Security Mount

On the inside of the Apple III, just to the left of the internal speaker, is a hole in the baseplate of the Apple III through which you can install a strong bolt. With this bolt, you can secure the Apple III to a table, shelf, chain, or other secure stronghold to prevent theft.

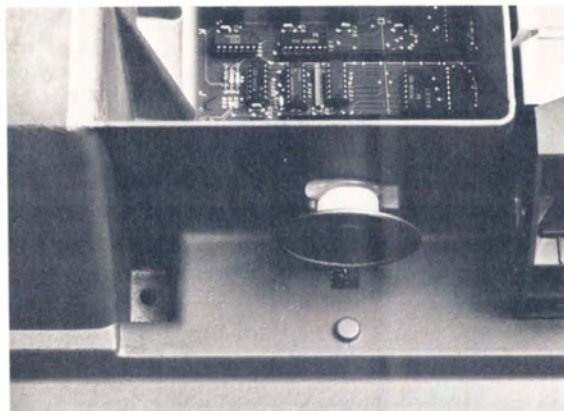

Security Mount and Bolt

The hole is unthreaded, .25 inch in diameter, and .15 inch deep. The well around the top of the hole is .5 inch wide and 1.25 inches long.

Replacing the Cover

To replace the cover on your Apple III, fit it onto the top of the Apple III so that the back of the cover is flush with the back of the computer and the holes on the underside of the front of the cover fit over the two quarter-turn screws. Retighten the two screws by pushing up on them and turning them each one-quarter turn in either direction with a flat-bladed screwdriver (you might have to tilt the Apple III up again to do this).

The Bottom

The bottom of the Apple III contains access panels for the power supply and main board electronics. You should never open either of these panels: they are for authorized service personnel only and opening them may invalidate your warranty.

Error Messages

Errors During Startup

Diagnostic Messages

When you turn on your Apple III, it performs a number of diagnostic checks on its hardware. If any of these tests fail, you will get one of the diagnostic messages below. If you get one of these messages, see your dealer. Do not use the computer: a defective computer could erase data from your diskettes.

RAM The test of the Apple III's random-access memory failed. The pattern on the screen indicates which component is faulty. See your dealer.

ROM The test of the Apple III's read-only memory failed. See your dealer.

ACIA The test of the Asynchronous Communications Interface Adapter (ACIA), which controls the RS-232-C serial port, failed. See your dealer.

VIA The test of the Versatile Interface Adapters (VIAs), which control various internal functions in the Apple III, failed. See your dealer.

A/D The test of the Analog-to-Digital converter, which controls the joysticks, failed. See your dealer.

ZP The Zero Page test, which determines whether the Apple III's memory addressing circuitry is operational, failed. See your dealer.

SOS Errors

If the Apple III passes the diagnostic tests, it tries to boot the diskette in the built-in drive. If an error occurs during the boot process, a message is displayed (in black characters on a white background) in the middle of the video screen, the Apple beeps, and the system waits for you to try again. Any boot error is a fatal error: you must insert a proper boot diskette, hold down the CONTROL key and press the RESET button to reboot, generally with a different diskette.

These errors can be produced during a bootstrap operation:

(Blank screen) The diskette in the built-in disk drive is not a boot diskette. Insert a proper boot diskette into the built-in disk drive, hold down the CONTROL key and press RESET to attempt to reboot.

RETRY The disk boot failed. Either there is no diskette in the built-in disk drive, or the diskette is unformatted, or the data on the diskette has been destroyed; or the diskette is not inserted straight. Remove and reinsert the diskette, making sure it is straight. If the error occurs repeatedly, place a known good boot diskette in the built-in drive, close the door, and attempt to reboot. If the error occurs with several boot diskettes, see your dealer.

DRIVER FILE NOT FOUND There is no file named SOS.DRIVER listed in the volume directory of the boot diskette. SOS cannot operate without device drivers, and the drivers must be stored in a file with this name, in the volume directory of the diskette.

DRIVER FILE TOO LARGE The SOS.DRIVER file is too large to fit into the system's memory along with the interpreter. Use the System Configuration Program to remove one or more drivers from this file.

EMPTY DRIVER FILE The SOS.DRIVER file contains no device drivers. SOS requires at least one device driver, usually .CONSOLE, to operate most interpreters.

INCOMPATIBLE INTERPRETER The interpreter is either too large or specifies a loading location that conflicts with SOS. This error usually occurs when trying to load an older interpreter with a newer version of SOS.

INTERPRETER FILE NOT FOUND There is no file named SOS.INTERP listed in the volume directory of the boot diskette. SOS cannot operate without an interpreter, and the interpreter must be stored in a file with this name, in the volume directory of the diskette.

INVALID INTERPRETER FILE The SOS.INTERP file is not in the proper format for an interpreter file. This error occurs when a file that is not an interpreter is assigned the name SOS.INTERP and the system is then booted.

INVALID DRIVER FILE The SOS.DRIVER file is not in the proper format for a driver file. Make sure that the file was either created by the System Configuration program or obtained from a valid Apple III boot diskette.

I/O ERROR The loader has encountered an I/O error while trying to read the kernel, interpreter, or driver file from the diskette in the Apple III's internal disk drive. Make sure the diskette is correct and properly inserted in the drive. If the error occurs with several boot diskettes, see your dealer.

KERNEL FILE NOT FOUND There is no file named SOS.KERNEL listed in the volume directory of the boot diskette. The files SOS.KERNEL, SOS.INTERP, and SOS.DRIVER must all be present in the volume directory of a diskette to be booted.

ROM ERROR: PLEASE NOTIFY YOUR DEALER Your Apple III contains an older version of the bootstrap ROM, which is not supported by this version of SOS. Your Apple dealer should be able to replace the ROM at no cost. If you receive this message, please contact your dealer or the nearest Apple Service Center.

TOO MANY BLOCK DEVICES The SOS.DRIVER file contains too many block device drivers. Use the System Configuration Program to remove one or more of the block device drivers from this file.

SCP Errors

These errors are reported during the operation of the System Configuration Program.

No device drivers have been read You're not allowed to do lots of things until you've read at least one.

Errors In Reading Driver Files

Illegal wildcard Either (a) two wildcards were used where only one is allowed, or (b) a wildcard was used when only a single file is allowed (e.g., you can't send a directory listing to multiple files).

Invalid pathname The specified pathname violates the syntax rules for pathnames. A common error is more than 15 characters in a local name.

Pathname too long The specified pathname has more than 80 characters.

Errors In Editing System Parameters

File contents incorrect The character set or keyboard set contains invalid data.

Slot number may not be altered for this driver This driver works only if its device is in a particular slot.

Errors While Generating System

These errors will not prevent SCP from generating the system configuration, but they indicate that the system may not work.

Character set not loaded Use Edit System Parameters to set the required items.

Duplicate driver names Use Edit Driver Parameters to change driver name of one of two.

Keyboard layout not loaded Use Edit System Parameters to set the required items.

One or more drivers require slot assignments Use Edit System Parameters to set the required items.

System parameters are not set Use Edit System Parameters to set the required items.

Filer Errors

These errors are reported during the operation of the Filer:

Bad disk medium/drive The disk has been physically damaged and is unusable, or the disk drive is malfunctioning.

Blocked volume name expected You specified a character device name when a block device name was expected.

Cannot read source diskette The diskette that you are trying to make a copy of is unreadable. Make sure you have specified the proper source and destination drives, and that the diskette is correctly inserted in the source drive.

Command requires SOS-format disk This command (e.g., Make a subdirectory) works only on SOS disks, not on UCSD-format disks.

Device dependent error #N See manufacturer's documentation. The specified device is not connected to the system or is turned off.

Device not configured into the system The driver for the specified device is not in the system configuration.

Device not on line The specified device is not connected, not turned on, or (if a block device) has an open door or contains no volume or an unformatted volume.

Directory already exists The specified operation will create a directory with the same name as one that already exists. As this operation will delete the old directory, you will be asked to confirm your intention.

Directory full The specified operation would put more files into a directory than it can hold. One solution is to Make a larger subdirectory and copy the files to it.

Disk drive not present/not configured You specified a disk drive that you either have not physically installed in your system or have not configured your Utilities diskette to recognize. Make sure that your daisy-chain cables are connected securely, and use the System Configuration Program (see the chapter The Utilities Diskette) to configure your boot diskettes for the proper number of disk drives.

Error #N Internal program error. The number N is returned by the language interpreter: see the manual for the language.

File already exists SOS does not allow two files to use the same pathname. The specified operation will create a file with the pathname of a file that already exists, or will change the pathname of one existing file to that of another. If this happens, you will be asked for confirmation, and if you give it, the old file of that pathname will be deleted so that the new file can use the pathname.

File expected This operation works only on files, and you specified something that was not a file.

File or blocked volume expected This operation works only on files or block devices, and you specified a character device.

File or character device expected This operation works only on files or character devices, and you have specified something else, like a block device.

File open: access not permitted This error usually occurs when you have tried to delete a file that is open for access, such as a program that is executing. If you tried to delete SYSTEM.STARTUP from a boot diskette while that file's program was running, you would get this error.

Formatter device driver not present in system The formatter device driver for a drive must be configured into the system before a drive can be used for formatting or copying volumes. These drivers can be found in the SOS.DRIVER file on the Utilities diskette.

Illegal disk format for this operation Either (a) you tried to do something to a SOS disk that can only be done to UCSD disk, or (b) you tried to do something to a UCSD disk that can only be done to SOS disks.

Illegal character in volume name The volume name must contain only letters, numbers, and periods; the first character must be a letter.

Illegal device name device name must start with a period, followed by a letter, followed by no more than 13 letters and numbers.

Illegal volume name length The volume name must not exceed 15 characters.

Illegal wildcard Either (a) two wildcards were used where only one is allowed, or (b) a wildcard was used when only a single file is allowed (e.g., you can't send a directory listing to multiple files).

Invalid copy The specified copy operation is impossible: e.g., copying a subdirectory to itself.

Invalid number The number violates a syntax rule: usually, because it contains a space or a comma.

Invalid pathname The specified pathname violates the syntax rules for pathnames. A common error is more than 15 characters in a local name.

I/O error during format operation Unidentified input/output error, such as an open drive door, no diskette, or an unformatted diskette.

I/O error Unidentified input/output error, such as an open drive door, no diskette, or an unformatted diskette.

Medium is write-protected or not present The diskette you are trying to format or copy onto is write-protected or is not present. If you wish to destroy the information on a write-protected diskette, remove the diskette from the drive, peel off the small tab that covers the write-protect notch, and reinsert the diskette. If the diskette is not write-protected, the drive may be configured in but unplugged.

Not enough memory (too many files at once) The specified directory is too large to load into memory.

Not enough memory to do copy The volume directory has filled all available memory, leaving no room for storing information to be copied to another volume. The usual causes are (a) too many device drivers configured into the system, and (b) too large a directory to fit into memory. The solution may be to remove some drivers from SOS.DRIVER . See the *Standard Device Drivers Manual* for details.

No room on volume The specified operation would try to put more information on a volume than it can hold.

Pathname too long The specified pathname has more than 80 characters.

Root directory expected This operation works only on a volume, or root directory, and you specified something else (e.g., Verify works only on volumes, not files).

Subdirectory expected This operation works only on subdirectories, and you have specified something else.

Subdirectory not found. The specified subdirectory is not on the specified volume or device.

Unable to read file or directory File or directory contains invalid data.

Volume already on line The specified volume has the same name as another volume already in the system. If you copy the Utilities diskette to a volume in another drive, then try to read the directory of the copy, you will get this error.

Volume not found (a) The specified file was not in any of the devices known to the system. (b) The specified device has no volume in it.

Write-protect error The file or volume specified is write-protected and cannot be deleted or written to.

General Errors

SYSTEM FAILURE Indicates a catastrophic failure of SOS, from which the only recovery is to reboot your system. System failures are rare and usually can be attributed to sudden hardware failure or an unknown error in the operating system or language interpreter. If you receive the same system failure at the same place in the same program more than once, your program has probably encountered an error in the language or operating system. Please report such errors to your dealer, and fill out a User Input Report, so that they can be corrected in a future release of SOS.

- 01 : Reentrant system call.
- 02 : Interrupt not found.
- 03 : Too many nested interrupts.
- 04 : Unable to allocate NMI.
- 05 : Event queue overflow.
- 06 : Stack overflow.
- 07 : Invalid request code.
- 08 : Reserved.
- 09 : Memory size less than 64Kbytes.
- 0A : Invalid volume control block.
- 0B : Invalid file control block.
- 0C : Invalid allocation blocks.
- 0D : Pathname buffer overflow.
- 0F : Invalid buffer number.
- 10 : Invalid buffer request.

B**Care and Handling*****Care of the Apple III***

Treat your Apple III as carefully as you would treat a good-quality electric typewriter: don't bump or jar it too much, try to keep it level on the surface of a desk or table, and don't spill any liquids on it. Even though the Apple III is mostly electronic, its mechanical parts (such as the disk drive) are delicate, and will become misaligned if subjected to physical abuse.

The Apple III has no ventilating fan, and the only way it can dissipate heat is through the cooling fins on the back and sides of the case. Always be sure your Apple III has adequate ventilation, and that the ambient air temperature doesn't get too high. Constant operation at high temperature will drastically shorten the lives of the components in the Apple III.

Keep the disk drive door closed. An open door is an invitation to dust and other foreign particles which could degrade the performance of the disk drive.

Above all, use common sense. Don't drop anything heavy on the Apple III's keyboard, and don't drop the Apple III itself onto anything. If you have obtained the vinyl carrying case for the Apple III, use it; it was specifically designed to transport the Apple III safely and comfortably. If you're going to be shipping the Apple III by freight, pack it in its original packing material, and make sure it's packed tightly.

Care of Diskettes

Never let anything touch the brown or grey surface of the plastic disk inside the diskette package. Handle the diskette only by its black plastic cover. When a diskette is not in use, keep it in the paper envelope it came in. These envelopes are treated to minimize static build-up which attracts dust. It is best to store diskettes vertically when they are not in use. There are convenient vinyl notebooks made especially for this purpose.

Diskettes hold a tremendous amount of information: a single diskette can hold over a million bits of information. An individual bit, therefore, occupies a very small portion of the diskette. An invisible scratch on the surface of the diskette, or even a fingerprint, can cause errors. Do not place diskettes on dirty or greasy surfaces; do not let them collect dust.

To write on a diskette label, use a FELT TIP pen or marker, never a pencil or ball point pen. Do not press hard. It is best not to write on a label attached to a diskette: instead, write on the separate label, then attach it to the diskette.

Keep diskettes away from magnetic fields. This means keep them away from electric motors and magnets; they should not be placed on top of television sets or other electronic devices. Don't leave them on top of the Apple III; the magnetic field generated by the transformer in the Apple III's power supply could erase information on the diskette.

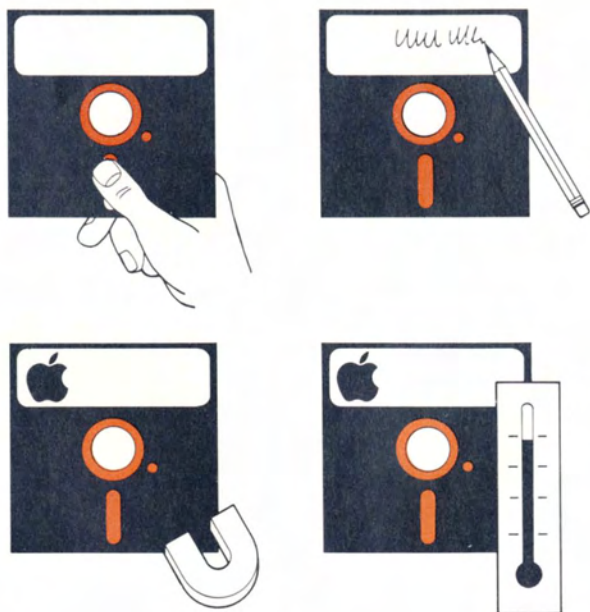

Don't Do This

Diskettes are sensitive to extremes of temperature. Keep diskettes out of the sun, and away from other sources of heat which could cause them to warp. On hot days, car dashboards or glove compartments can be diskette killers. Diskettes can be damaged by temperatures as low as 125 degrees Fahrenheit (51.7 Celsius), which is not very hot. The first evidence of heat damage is a warped or bent plastic cover. For optimum long-term storage, keep diskettes at a temperature between 60 and 70 degrees Fahrenheit (15 to 20 degrees Celsius).

If you want to protect the information on your diskette from accidental erasure by the Apple III, just stick one of the small silver adhesive-tape tabs supplied with your diskettes over the rectangular notch in the right side of the diskette. When this notch is covered, the computer is prevented from writing any information onto the diskette, or changing the information which is already there. To store information on the diskette, you must first remove the tab. The write-protect tab will not, of course, prevent loss of data due to the accidents mentioned above.

With reasonable care, a diskette will give you an average life of about 40 operating hours—which is a lot, when you consider the few seconds it takes to load a file from a diskette. But with just a little bit of carelessness, a diskette may give you no service at all.

C

Input/Output Port Specifications

The following section provides the information you need to connect devices to Apple III ports, pin by pin.

Port A: Joystick Input

This port contains circuitry for two analog devices (usually potentiometers) and two digital devices (usually switches). The analog inputs accept input voltage in the range of 0 to +2.2 volts and sink $3\mu\text{a}$ input current. The digital inputs are TTL.

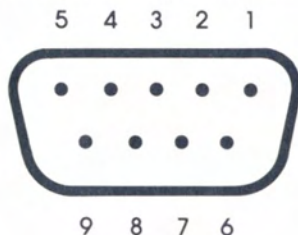

Pin	Name	Description
1	GND	Shield ground.
2	+5	+5 volt power supply.
3	GND	Power and Signal ground.
4	JS1-X	Horizontal analog input, read by pdl(2); in Emulation mode, equivalent to Apple II Paddle 0 (GC0) input, read by PDL(0).
5	JS1-B	Joystick pushbutton input, read by button(2); in Emulation mode, equivalent to Apple II Paddle 0 button (PB1) input, read by PEEK(-16287).
6	+12	+12 volt power supply.
7	GND	Power and signal ground.
8	JS1-Y	Vertical analog input, read by pdl(3); in Emulation mode, equivalent to Apple II Paddle 2 (GC2) input, read by PDL(2).
9	JS1-Sw	Joystick switch input, read by button(3); in Emulation mode, equivalent to Apple II Paddle 2 button (PB3) input, read by PEEK(-16285).

Port B: Joystick Input

This port contains circuitry for two analog devices (usually potentiometers) and two digital devices (usually switches). The analog inputs accept input voltage in the range of 0 to +2.2 volts and sink $3\mu\text{a}$ input current. The digital inputs are TTL.

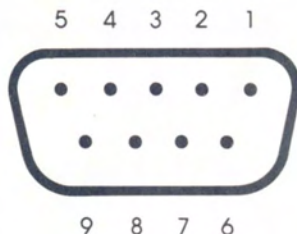

Pin	Name	Description
1	GND	Shield ground.
2	+5	+5 volt power supply.
3	GND	Power and signal ground.
4	JS0-X	Horizontal analog input, read by <code>pdl(0)</code> ; in Emulation mode, equivalent to Apple II Paddle 1 (GC1) input, read by <code>PDL(1)</code> .
5	JS0-B	Joystick pushbutton input, read by <code>button(0)</code> ; in Emulation mode, equivalent to Apple II Paddle 1 button (PB2) input, read by <code>PEEK(-16286)</code> .
6	+12	+12 volt power supply.
7	GND	Power and signal ground.
8	JS0-Y	Vertical analog input, read by <code>pdl(1)</code> ; in Emulation mode, equivalent to Apple II Paddle 3 (GC3) input, read by <code>PDL(3)</code> .
9	JS0-Sw	Joystick switch input, read by <code>button(1)</code> ; not used in Emulation mode.

Here is a sample circuit for a joystick with two potentiometers, one pushbutton, and one switch. The value of the potentiometers can range from 1K ohm to 700K ohm, although with the higher value, only 20% of the potentiometer's range will be used.

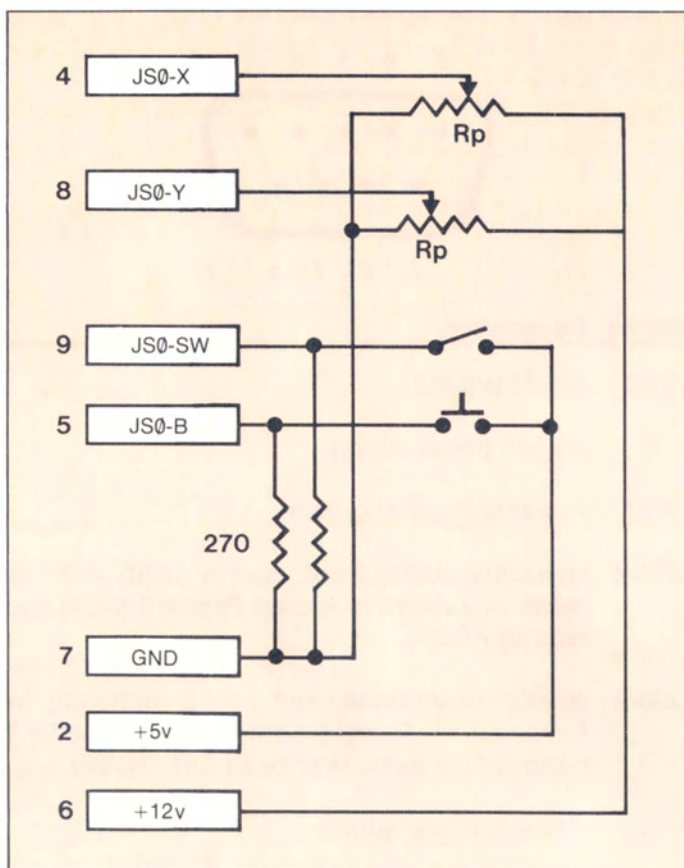

Port C: RS-232-C Serial Interface

The Apple III is classified as Data Terminal Equipment (DTE) under the EIA RS-232-C communications protocol. It can be directly connected to a piece of Data Communications Equipment (DCE), such as a modem. To connect the Apple III to another piece of Data Terminal Equipment (such as a printer), you must use a modem eliminator.

All output levels are minimum +6 volts when active and maximum -6 volts when inactive measured into a 3K ohm load.

All inputs have a turn-on threshold of +1.25 volts and a turn-off threshold of +.8 volts typical. All inputs sink 10mA current.

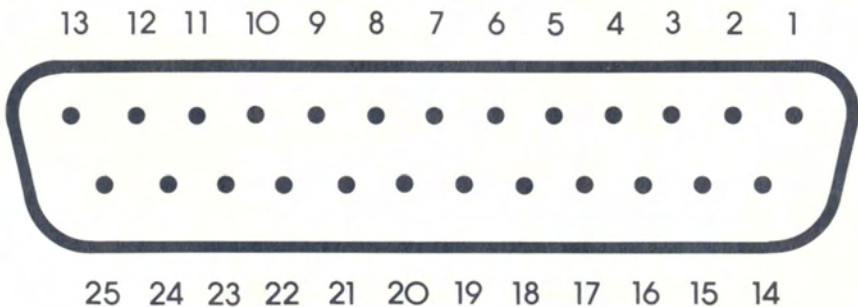

Pin	Name	Description
1	SGND	Shield ground.
2	TXD	Transmitted data; serial data output from the Apple III.
3	RCD	Received data; serial data input to the Apple III.
4	RTS	Request to Send output; this indicates that the Apple III is ready to transmit data.
5	CTS	Clear To Send input; this acknowledges that the Apple III may begin transmission.
6	DSR	Data Set Ready input; this acknowledges that the remote device is on and operational.

Pin	Name	Description
7	GND	Signal ground.
8	DCD	Data Carrier Detect input; this acknowledges that the remote device is ready to transmit data.
9-19		No connect.
20	DTR	Data Terminal Ready output; this indicates that the Apple III is on and operational.

The Color Video Port

This connector supplies seven different video signals and four power supply voltages. Through this connector you can hook up the Apple III to any NTSC-compatible color or black-and-white video monitor. With an additional circuit you can hook up the Apple III to a studio-quality RGB-compatible color monitor.

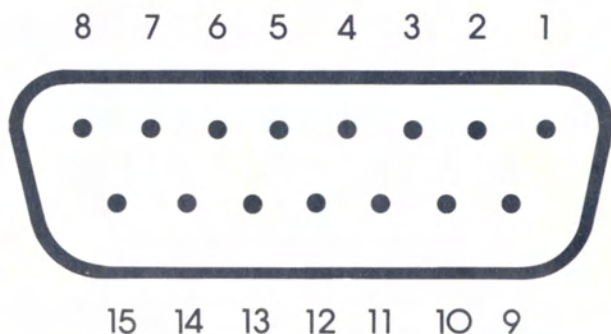

Pin	Name	Description
1	SG	Shield ground.
2	XRGB4	One of four RGB outputs. This (and pins 5, 9, and 10) is a TTL output with instantaneous color information. A linear-weighted sum of these four signals will form a true 16-color RGB video signal (see the circuit below).

Pin	Name	Description
3	SYNCH	Composite synchronization signal with negative-going sync.
4	PDI	Not used.
5	XRGB1	See pin 2.
6	GND	Power and signal ground.
7	-5V	-5 volt power supply. A device may draw up to 200 mA through this pin.
8	+12V	+12 volt power supply. A device may draw up to 500 mA through this pin.
9	XRGB2	See pin 2.
10	XRGB8	See pin 2.
11	BWVID	Black and white composite video. This is an NTSC compatible video signal with negative-going sync, 1 volt peak-to-peak into a 75 ohm load. Color information is encoded as a linear grey scale.
12	NTSC	Composite color video. This is an NTSC-compatible video signal with negative-going sync, 1 volt peak-to-peak into a 75 ohm load.
13	GND	Power and signal ground.
14	-12V	-12 volt power supply. A device may draw up to 200 mA through this pin.
15	+5V	+5 volt power supply. A device may draw up to 1 amp through this pin.

All power supply current ratings assume that no peripheral cards are installed in the system. If there are cards in the system, the current drawn by those cards counts as part of the total current available from each supply.

The four XRGB signals should be fed to the network shown below. The input signals are buffered through emitter-follower circuits, then go into a resistor weighting network, which adds the input signals to generate the standard color set. The output signals from the resistor weighting network are buffered through emitter-follower circuits. The resulting RGB-compatible signals can be connected to an RGB monitor. The SYNC signal (pin 3) may also need to be connected to the RGB monitor.

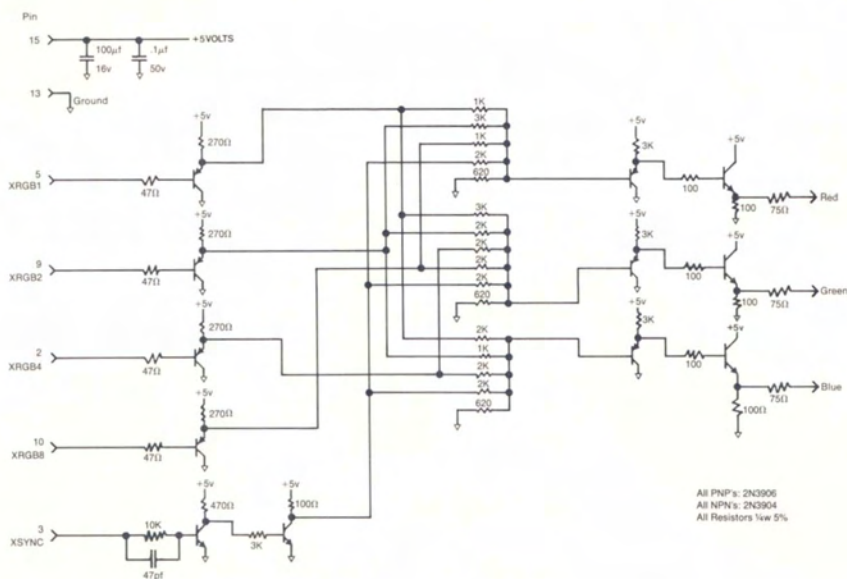

RGB-Compatible Output Network for Apple III

The B/W Video Port

This RCA connector carries the BWVID black and white NTSC-compatible video signal (same as pin 11 on the color video connector) on its tip and signal ground on its ring.

The Audio Port

This miniature phone jack carries a 0.5 volt peak-to-peak audio signal on its tip and signal ground on its ring. When a miniature phone plug is inserted in this connector, the Apple III's internal speaker is disabled.

D

The Apple II Emulation Diskette

The Apple III has a feature, called Apple II Emulation, that allows it to run most Apple II software. It does this by imitating, or emulating, the behavior of the Apple II. A diskette called the Apple II Emulation diskette lets you run programs written for the Apple II Plus (or Apple II) on your Apple III computer. While you are using the Emulation diskette, none of the advanced features of the Apple III are available to you: you can only use Apple II functions.

When you use the Emulation diskette for the first time, your Apple III acts like a 48K Apple II Plus with Applesoft II BASIC, a 16-sector Disk II controller card, and a Serial card. You can also change the diskette so that the Apple III emulates an Apple II with Integer BASIC, or either type of Apple II with a communications card.



You cannot configure the Apple III to emulate an Apple II with a Language Card, an Applesoft Card, or an Integer BASIC card. Run-Time Pascal programs will run in Apple II Emulation; programs which require the Language Card will not. The section Limitations tells what types of Apple II programs will run in Apple II Emulation.

Apple II Emulation assigns the Apple III's built-in disk drive to be the equivalent of slot 6, drive 1, on an Apple II; it assigns the first additional disk drive to be the equivalent of slot 6, drive 2. Apple II

Emulation makes the Apple III's built-in RS-232-C serial port act like an Apple II serial card or, optionally, an Apple II communications card, plugged into slot 7 or slot 5.

Using Applesoft

You boot the Emulation diskette the same way you boot a normal Apple III diskette: by inserting it into the built-in drive and pressing CONTROL-RESET. After you boot it, you see the boot menu:

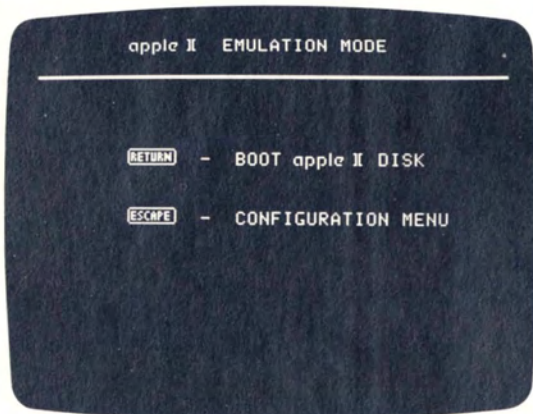

The Apple II Emulation Boot Menu

The Apple II Emulation diskette is initially set up to be used for diskettes from an Apple II Plus with Applesoft BASIC and a Serial card. To boot an Apple II Plus diskette that uses Applesoft, insert the diskette into the built-in drive and press RETURN. Most software for the Apple II Plus can be booted in this way. If you want to use Integer BASIC, or if your program expects to send information to a communications card, read on.

The Emulation Options

Boot the Emulation diskette. If your diskette needs Integer BASIC, or a communications card, or some other change in the standard setup, press ESCAPE to get this menu:

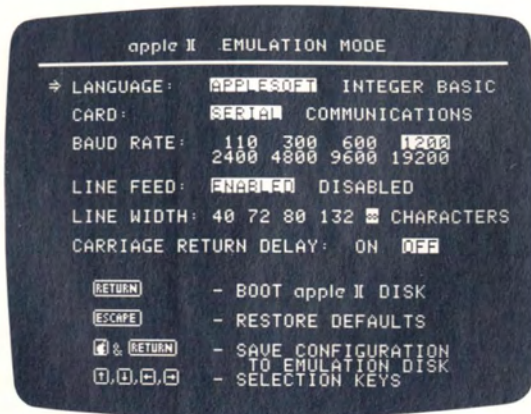

The Apple II Emulation Configuration Menu

Below the title is a menu with six characteristics, each followed by its options. The bottom of the screen shows all the ways to control the selection and use of the options. The options that are selected at any time are highlighted in inverse video (black on white).

You can edit this menu with the four arrow keys. Do you see the arrow-shaped pointer before the word LANGUAGE? This pointer indicates the characteristic whose options you can change. Choose the characteristic you need to change with the up- and down-arrow keys. The left- and right-arrow keys let you choose the option that you need. Once you have chosen the options you want, you can boot with the new configuration, or store the configuration on the Emulation diskette.

These are the six different characteristics and their meanings.

Language: Applesoft Integer BASIC

Integer and Applesoft BASIC are both emulated as if you are using an Apple II with an Autostart ROM. Integer BASIC includes Programmer's Aid #1. Only one language can be in memory at a time; to change from one language to the other, you must boot the Emulator.

Card: Serial Communications

A *serial card* sends data, usually to a printer; a *communications card* sends and receives data through a modem.

Baud Rate: 110 300 600 1200 2400 4800 9600 19200

Sets the rate at which the Apple sends and receives data. Usually, you'll use 1200 baud (baud means bits per second), for compatibility with a Qume printer.

If the *Card* is a *Serial* card, you can change these additional characteristics:

Line Feed: Enabled Disabled

ENABLED adds a line feed after a carriage return, needed by some printers; DISABLED does not.

Line Width: 40 72 80 132 ∞

When the LINE WIDTH is set to 40 characters, no line longer than 40 characters can be printed by a program. If the program prints 40 characters past the last carriage return, the Apple III sends out a carriage return to end the line. The options 72 , 80 , and 132 act similarly; the infinity option adds no carriage returns to the program output, no matter how long the line gets.

Carriage Return Delay: ON OFF

Some printers need extra time to return the carriage to the left margin. ON provides this delay.

You can return to the default values for all the characteristics by pressing ESCAPE. The default values are the options that are highlighted when you first enter the Configuration Menu.

To boot a diskette with the options that are currently selected (all the highlighted options), place your Apple II boot diskette into the built-in drive and press RETURN. Doing so does not reset the default values.

If you want to save the options that are currently selected, press RETURN while holding down Closed Apple. The Emulation diskette must be in the built-in drive. You may now boot an Apple II diskette by pressing RETURN again.

If you do not wish to use DOS, you can press the RESET button immediately after pressing RETURN. The system will then run in the language you choose, without a disk operating system.

To leave Apple II Emulation, simply re-boot the Apple III with a SOS diskette. Insert the diskette and press CONTROL-RESET.

Limitations

Apple II Emulation cannot exactly duplicate the behavior of an Apple II. These are the known limitations:

Software

You cannot have both BASIC languages in memory simultaneously. To change BASICs, you must reboot the Emulation diskette.



A number of diskettes have menus, written in one BASIC, that call programs written in another BASIC. If you can read the CATALOG of the diskette, you find out the name of the program you want to run, and which BASIC it's written in; then you can boot with the appropriate BASIC and RUN the individual program. This may not be possible with some copy-protected diskettes.

In Apple II Emulation, you cannot run any Pascal programs that require the Language Card when run in the Apple II. However, the

Pascal Run-Time System lets you run programs like the Tax Planner in Emulation mode. The Pascal System on the Apple III runs only in Apple III mode; however, Apple II Pascal programs can be recompiled to run on the Apple III.

Apple II Emulation is designed to use Apple II DOS 3.3. In order to use DOS 3.2 diskettes in the Emulator, you should first update them using the FID and MUFFIN programs on your DOS 3.3 boot diskette. See your DOS 3.3 manual (or your dealer) for more information. If some of your 3.2 diskettes are copy-protected and you can't update them to 3.3, you can boot the DOS 3.3 BASICS diskette, then your protected diskettes. This alternative requires a good deal of diskette-swapping, so update diskettes if you can.

Peripherals

You cannot use an Apple II Language System, an Applesoft II or Integer BASIC Firmware card, or most other Apple II peripherals with your Apple III.

Some Apple II programs require a serial or communications card in a particular slot. If this slot is not 7 or 5, these programs will not run on the Emulator, unless you put an Apple II serial or communications card into the required slot of the Apple III.

The Apple III does not have a cassette interface, so the BASIC LOAD and SAVE commands, as well as all other commands that use the cassette interface, do not work.

The Apple III Emulator has no annunciator outputs. The memory locations the Apple II uses for the annunciator outputs are used by the Apple III Emulator for reading the joysticks. For this reason, any program that uses the annunciators at the same time as it reads the joysticks gets erroneous joystick readings.

Game Inputs

The Apple III does not have an Apple II Game I/O connector, but the Emulator recognizes the Apple III joysticks as game paddles. The table below shows the relationships between the Apple III joystick inputs and the Apple II game-paddle inputs.

Relationship Between Emulation Mode Joysticks and Apple II Game Paddles

Analog Inputs (Potentiometers)

<i>Apple III</i>			<i>Apple II</i>			
Port/Pin	Direction	SOS Name	A III BASIC	Paddle	A II Name	Applesoft BASIC
B/4	Horiz	JS0-X	pdl(0)	1	GC1	PDL(1)
B/8	Vert	JS0-Y	pdl(1)	3	GC3	PDL(3)
A/4	Horiz	JS1-X	pdl(2)	0	GC0	PDL(0)
A/8	Vert	JS1-Y	pdl(3)	2	GC2	PDL(2)

Digital Inputs (Pushbutton and Toggle Switches)

<i>Apple III</i>			<i>Apple II</i>			
Port/Pin	Direction	SOS Name	A III BASIC	Paddle	A II Name	Applesoft BASIC
B/5 \$C062	Button	JS0-B	button(0)	1	PB2	PEEK(-16286)
B/9 \$C060*	Switch	JS0-SW	button(1)	3*	PB0*	PEEK(-16288)*
A/5 \$C061	Button	JS1-B	button(2)	0	PB1	PEEK(-16287)
A/9 \$C063	Switch	JS1-SW	button(3)	2	PB3	PEEK(-16285)

* Note that on an Apple II, Paddle 3 cannot have a pushbutton, as memory location \$C060 is used for cassette input. Any program that reads this location as a pushbutton input works in Emulation mode, but not on an Apple II.

The Apple III Emulator uses a modified form of the Autostart ROM's paddle-reading routines, PDL(0) through PDL(3) in BASIC, to read the joysticks. Any Apple II program that uses its own routines for these functions will not run on the Emulator.

Video

The Apple III's RGB color video outputs do not generate a color signal for High-Resolution Graphics in the Emulator. Apple II High-Resolution images are available only on the NTSC black and white and color video outputs.

Dots on the left border of the high-resolution graphics screen flicker uncontrollably.

Firmware and Hardware

The subroutines in the Apple II's monitor ROM that handle Non-Maskable Interrupts (NMIs), annunciators, cassette input and output, and paddle input have been altered. The NMI vector in the Emulator is the same as the Reset vector. Cassette input and output have been removed and are inoperable.

The RESET button on an Apple III in Emulation mode does not operate the same as the Apple II RESET button in that it generates a Non-Maskable Interrupt, not a true reset. Holding down CONTROL while pressing RESET causes the Apple III to attempt to boot a diskette.

Keyboard

The symbols

@ ^ & (*) : + = - " '

in the Apple II character set have been relocated on the Apple III keyboard. Although these symbols can still be generated by the keyboard, different keystrokes are required to generate them.

Several keys on the Apple III keyboard produce characters the Apple II keyboard cannot produce. When they are sent to the

Emulator's screen, different characters are displayed. The table below shows the characters produced by these keys, followed by the characters displayed, for all combinations of the SHIFT and CONTROL keys. Some of these characters are not displayed at all (the cursor does not move): these are denoted (ND) below. Others display as spaces (the cursor moves one space): these are denoted (SP) below. The two- and three-letter abbreviations are the ASCII symbols for control characters.

Key	Alone		CONTROL		SHIFT		Both	
	Char	Disp	Char	Disp	Char	Disp	Char	Disp
—	-	-	-	-	—	—	US	(ND)
	\	\	FS	(ND)		<	DEL	?
{	[[ESCAPE	(ND)	{	;	ESCAPE	(ND)
}]]	GS	(ND)	}	=	GS	(ND)
~	^	(SP)	^	(SP)	~	>	~	>



Some programs may give unexpected responses if they receive characters not in the Apple II character set. CTRL-SHIFT-2 on the Emulator (CTRL-SHIFT-P on the Apple II) produces ASCII NUL (\$00), which halts many programs. CTRL-S on both machines suspends screen output until pressed a second time.

A Word of Advice

We don't recommend writing programs that exploit quirks of Emulation mode, such as the Paddle 3 button input, that are absent on the Apple II or Apple II Plus. If you want to write a program that runs only on the Apple III, Apple III Business BASIC will probably serve you better than Applesoft or Integer BASIC. If you want to write a program that runs in Emulation mode, it will be more useful if you write it so that it will run on either the Apple II or Apple II Plus.

System Specifications

Operating System

Version: SOS 1.1

Classification:

Single-task, configurable, interrupt-driven operating system.
File system—hierarchical, tree file structure.
Device-Independent I/O.

CPU Architecture:

Address enhanced 6502 instruction set.
Supports both bank-switched and enhanced indirect addressing.
Separate execution environments for user and SOS including private zero and stack pages.

System Calls:

Based on 6502 BRK instruction, pointer, and value parameter types.
Error codes returned via A register.
All other CPU registers preserved upon return.
Optional parameter lists for future expansion.

File Management System:

Hierarchical file structure.

Pathname prefix facility.

Byte oriented file access to both directory/user files and device files.

Dynamic, non-contiguous file allocation on block devices.

Automatic buffering (current index block and data block).

Dynamic memory allocation of file buffers.

Block size (512 bytes).

File protection: rename/destroy/read/write access attributes.

File level assignment on Open.

Automatic date/time stamping of files.

Automatic volume logging/swapping, supported by system message center.

Multiple volumes per block device can be "open" simultaneously.

Sparse file capability.

maximum # of active volumes = 8

maximum disk size = 32 Mbytes

maximum user file size = 16 Mbytes

maximum file entries in volume directory = 51

maximum file entries in a subdirectory = 1663

file names—maximum 15 characters

pathnames—maximum 128 characters

File system calls:

Create

New_line

Destroy

Read

Rename

Write

Set_file_info

Close

Get_file_info

Flush

Volume

Set_mark

Set_prefix

Get_mark

Get_prefix

Set_eof

Open

Get_mark

Device Management System:

Block and character device classes.
 Standardized interface for block and for character devices.
 All devices are named and configurable.
 Support for synchronous, interrupt, and DMA-based I/O.

maximum number of devices	= 24
maximum number of block devices	= 12

Device system calls:

Get_dev_num	D_status
D_info	D_control

Memory/Buffer Management System:

All memory allocated as segments.
 Supports maximum of 512 Kbytes RAM.
 System buffers allocated and released dynamically.
 System buffer checksum routine for data integrity.

Memory system calls:

Request_seg	Get_seg_info
Find_seg	Get_seg_num
Change_seg	Rel_seg

Additional System Functions:

System clock/calendar
 (year/month/day/week day/hour/minute/second/ms).
 Joysticks: reads X and Y axis, pushbutton, and switch.
 Clean system termination via coldstart routine: clears memory.

System calls:

Set_time	Cold_start
Get_time	

Interrupt Management System:

Receives hardware interrupts (IRQ, NMI) and system calls (BRK).

Hardware resource allocation and deallocation.

Dispatches to driver interrupt handlers.

Event Management System:

Priority based event signaling.

Event handlers preempted by higher priority events.

Events with equal priorities process FIFO.

Event fence delays events with priority < fence.

Event system calls:

Set_fence

Get_fence

SYSTEM CONFIGURATION:

Menu-driven system-configuration editor (System Configuration Program).

Can add, remove, and modify drivers and can select the keyboard-layout and system-character-set tables.

Standard Device Drivers:

Floppy (.D1, .D2, .D3, .D4)

143,360 bytes (formatted) per volume.

Automatically reports mounting of a new volume.

Built into SOS kernel.

Console (.CONSOLE)

Interrupt-driven keyboard (supports type-ahead).
Configurable keyboard-layout table (via SCP).
Raw-keystroke and no-wait input modes.
Event handler supports anykey and attention character.
Optional screen echoing.

Console control modes:

- video on/off
- flush type-ahead buffer
- suspend screen output
- display control characters
- flush screen output

Cursor positioning commands.

Viewport set, clear, save, and restore commands.

Horizontal and vertical scrolling.

Text modes: 24x80 and 24x40 B&W and 24x40 color
(normal and inverse).

Configurable system character set table (via SCP).

Character set can be changed under program control at
any time.

Screen read command.

Graphics (.GRAFIX)

Displays graphical and textual information
simultaneously.

Graphics modes: 560x192 and 280x192 in B&W video.
280x192 and 140x192 in 16 colors.

Point-plotting and line-drawing commands using
graphics viewport and pen.

Raster block picture operations.

Color operator table, controls color overwrite.

Transfer modes allow binary operations on the drawing
color and the current screen color.

Allows use of either the system character set or an
alternate character set to display ASCII text on the
screen.

Single or dual graphics screens.

General purpose communications (.RS232)

RS-232-C interface.

Configurable data rates from 110 to 9600 baud.

Configurable protocols, including XON/XOFF, ETX/ACK, and ENQ/ACK.

Interrupt-driven, buffered, bi-directional data transfer.

Hardware handshaking option.

Serial printer (.PRINTER)

RS-232-C interface.

Configurable data rates from 110 to 9600 baud.

Interrupt-driven and buffered (output only).

Hardware handshaking option.

Audio (.AUDIO)

64 volume levels.

Produces tones from 31 to 5090 Hz (over 7 octaves).

Duration range from 0 to 5 sec (increments of 1/60 sec).

Hardware

Size:

17.5 inches wide (44.45 cm)

18.2 inches deep (46.23 cm)

4.8 inches tall (12.19 cm)

Cast aluminum base with molded plastic cover

Weight:

26 pounds (11.8 kg)

Processor:

Based on the 6502B microprocessor, with extended addressing capability

Clock Speed:

2 MHz peak, 1.4 MHz average

- Main Memory:** 128K (98,304) eight-bit bytes
Dynamic Random Access Memory
- ROM Memory:** 4K (4,096) eight-bit bytes initialization and diagnostics
- Power Supply:** High-voltage switching type
+5, -5, +12, -12 volts
UL approval pending
- Power Req:** 100 watts maximum, 107 to 132 volts, 60 Hz.
- Ambient Temp:** 15 to 35 degrees Celsius.
Critical factor is deformation temperature of diskette cases.
- Mass Storage:** One 5.25 inch (13.33 cm) floppy disk drive.
built-in 140K (143,360) bytes per diskette.
Up to 3 additional drives can be connected by "daisy chain" cables.
- Keyboard:** 74 keys (61 on main keyboard, 13 on numeric pad)
Full 128 character ASCII represented
All keys have automatic repeat except modifier keys
Five modifier keys: SHIFT, CONTROL, ALPHA LOCK,
and two program-definable "Apple" keys
Four directional arrow keys with two-speed repeat
Four other special keys: TAB, ESCAPE, RETURN,
ENTER
- Screen:** Three text modes:
40x24, black and white, normal and inverse
80x24, black and white, normal and inverse
40x24, 16 color, foreground and background
All text modes have a software-definable 128-character set
- Four graphics modes:
280x192, black and white
280x192, 16 color, foreground and background
140x192, full 16 color
560x192, black and white

- Video Output:** RCA phono connector for NTSC black and white composite video
DB-15 type connector for:
 NTSC black and white composite video
 NTSC color composite video
 RGB pure video
 Composite sync signal
 +5, -5, +12, -12 volt power supplies
Color signals appear as 16-level grey scale on black and white video outputs
- Audio Output:** Built-in 2-inch speaker
Miniature phone-tip jack on back of Apple III
Three different audio generators:
 64 level audio port (6-bit DAC)
 One-bit square-wave generator
 Fixed-frequency "beep" generator
- Serial I/O:** RS-232C compatible, DB-25 female connector
Software selectable baud rate and duplex mode
- Joysticks:** Two DB-9 connectors for two joysticks, two pushbuttons, and two switches
- Printer:** One DB-9 connector (shared with first joystick) for "Apple Silentype" printer
- Expansion:** Four 50-pin expansion slots inside the cabinet

Glossary

argument In general, a mathematical expression affected by some function. In the sentence, "Multiply six by eight" six and eight are arguments. Specifically in the context of programming for SOS drivers, arguments are additional data that follow commands and are necessary to their action.

audio driver The device driver that enables a program to produce sounds with the Apple III's built-in speaker.

back up To make a copy for safe keeping. In the event of a power failure, data writing errors, or a careless mistake that destroys information on a disk, a backup copy can save you much time and grief.

backspace To move the cursor one character to the left. There are two types of backspaces: destructive, which remove characters backspaced over from the screen; and non-destructive, which leave all characters intact.

block A unit of information 512 bytes long. The Utilities List command reports the sizes of disks and files in blocks.

block device A device that uses one block (512 bytes) of information as its basic unit of communication.

boot diskette A diskette containing all the programs and data that the Apple III needs to use a language and to communicate with at least some of its devices. When turned on with a boot diskette in the built-in drive, an Apple III will automatically start using the language on the boot diskette.

bootstrap or boot To get the system running. When you turn the system on, you need a "boot diskette" to get it running.

built-in Within the Apple III's case. The Apple III has a built-in speaker, disk drive, serial interface and so on.

catalog A list of the contents of a directory, typically a list of pathnames.

character Any symbol that has a widely-understood meaning. The Apple III has 128 different symbols in its character set. Some, such as letters, numbers, and punctuation, can be displayed on the monitor screen, and printed on a printer. Others are used to control various functions of programs or the Apple III (see control characters).

character device A device that uses one character (1 byte) as its basic unit of communication. The console and Silentype printer are both character devices.

command 1. Something you type at the keyboard to make the computer do something. For example, Copy in the Utilities program is a command. 2. In the context of programming to control devices, a character (usually a control character), embedded in the stream of characters sent from a program to a device driver, to instruct the driver to perform some function.

configure As used in this manual, to change the parameters of a driver with SCP to adapt SOS to some device or the like.

configuration The hardware and software arrangement of a system. Specifically, the configuration of SOS (which see) consists of its active drivers and their default parameters, and determines how the Apple III communicates with the console, disk drives, and other devices. You control the configuration of your system with SCP (which see).

connector The physical joining place for electrical or electronic devices. The back of the Apple III has connectors for a Silentype printer, a joystick, a serial interface, two video connectors and an audio printer. A connector is sometimes called a port.

console The Apple III's video display and keyboard together make up the console. This is the part of the Apple III you communicate with directly.

console control keys: You can use the 5,6,7,8, and 9 keys on the numeric keypad while holding down the CONTROL key to control output to the console.

console driver The program that enables the operating system of the Apple III to communicate with the console. It controls the reading of characters from the keyboard (with typeahead), cursor motion, and the display of text on the monitor screen.

control character A symbol you can create by pressing one of the Apple's keys while holding down the key labelled CONTROL. These symbols are not usually printed and are generally used to control computing functions; hence the name. Control characters can also be generated and transmitted by programs.

cursor The symbol, typically a white rectangle, that moves across the screen and indicates where editing and similar action will take place.

device A piece of computer hardware, such as a disk drive or monitor, other than the computer itself. Devices may be built-in devices or they may be external (also called peripheral) devices.

device driver The program that acts as a communications link between a device and the operating system. Before you can use a new device with your Apple III, you must use the System Configuration Program on the Utilities diskette to install and configure the driver for that device. The use of device drivers is described in the *Apple III Standard Device Drivers Manual*.

device name The name used in SOS pathnames to refer to a particular device, without regard to what files are associated with the device. Device names begin with a period and a letter, followed by up to 14 alphanumeric characters. For example the device name of the disk drive built into the Apple III is .D1 regardless of what diskette is in the drive.

directory A file that contains the names and locations of other files. These other files may themselves be directories, in which case they are called subdirectories. The list of the contents of a directory file is sometimes called a catalog.

disk A device for storing computer files that consists of a plastic metal disk coated with metal oxide that works the way metal oxide on recording tape works. Hard disks (which see), floppy disks (which see) and diskettes (which see) are kinds of disks. You must format a disk with the Format program on the Utilities diskette before the Apple III can write to or read from it.

disk drive The complete machinery and electronics that turn and read a disk, and receive and transmit files in a manner intelligible to a computer (to a device driver in the case of an Apple III).

diskette A 5-1/4-inch floppy disk, or smaller. Remember not to touch the magnetic surface of a diskette; handle it only by its plastic cover.

echoing Characters typed on the keyboard are sent first to the operating system, and then the operating system displays the characters on the monitor screen. It is the operating system echoing the keypresses that makes characters appear on the screen when you type.

external Not within the Apple's case. Usually used to refer to devices that are not built-in. The Apple III can have as many as three external disk drives. Synonym: peripheral.

file An orderly, named collection of information. The information you work with on your Apple III is stored in files named and organized by SOS. SOS files are usually stored on a disk. Each file on a disk is identified by a pathname (which see) unique to that disk. SOS organizes names and locations of files into a special type of file called a directory. The files in a directory may include subdirectories of other files on the disk.

file name See pathname.

floppy disk A disk made of metal-coated flexible plastic sealed in a protective envelope. Floppy disks are typically slower in response and smaller in storage, but cheaper and more portable than hard disks.

format To prepare a disk for use. When you format a disk by using the Format program on the Utilities disk, the Apple puts a magnetic outline for the storage of information onto the surface of the disk. You must format a disk before the Apple can write on it. Note: When you format a disk, all information that was previously on the disk is destroyed.

graphics driver A program that enables the Apple's operating system to communicate with the portions of memory designated as the storage areas for graphics (the graphics screens). The graphics driver allows you to plot points, draw lines, display characters, and place blocks of pre-defined shapes on any of the four graphics screens. It also allows you to read the setting of any dot on any graphics screen.

graphics modes The formats, in terms of color and resolution, of Apple III graphics.

hard disk A disk made of hard metal and sealed into a drive, or cartridge. Hard disks are typically faster in response and larger in storage, but higher in price and less portable than floppy disks.

initialization 1. The effect of the startup routines that automatically run when you turn on your Apple III. These routines reset all devices, clear the screen, set the character set, perform a diagnostic check of some of the Apple III's hardware, and load an operating system from the built-in drive. 2. The preparation of a disk for use. See format.

input/output (I/O) 1. A general term referring to the transfer of information between the Apple III and any device. 2. The information transferred between the Apple III and any device.

interpreter A program that translates each step in a high-level language (such as BASIC) into a series of low-level machine language operations and then carries out those operations before proceeding to the next step.

joystick A stick or lever whose motion controls the direction of movement of cursors and other computer functions.

Kernel In the Apple III, the part of SOS that directs the flow of information within the Apple III and among its devices.

list A verb in computer jargon, meaning to display on a monitor or print on a printer, the contents of the computer memory or a file.

load To bring into memory. When you turn on the Apple III, an operating system is loaded from the boot disk. You can also load alternate character sets, device drivers, and files.

local name The name of a file, directory, or subdirectory that omits the volume name (which see) for convenience. For example, the pathname /ACCOUNTING/PAYABLE/QUIGLY consists of three local names: ACCOUNTING, PAYABLE, and QUIGLY, naming a directory, subdirectory and file, respectively. You can only get at the file QUIGLY using its local name if the prefix is set to /ACCOUNTING/PAYABLE, otherwise you must use its full pathname.

memory The storage for programs and information that is inside the Apple III's case. Your Apple III has 4K bytes of permanent memory that contains initialization and diagnostic programs and a much larger memory (specified for each machine) for general use. Every time the Apple III accepts data from a device, information is stored into memory.

menu A list of choices. A program typically displays a menu on the monitor screen, and then waits for you to choose one of the items by name or number.

numeric keypad The thirteen keys on the right side of the keyboard. The symbols generated by these keys are normally the same as the symbols generated by the corresponding keys on the main keyboard (ENTER is the same as RETURN); however there is a

way to tell if the key pressed is on the numeric keypad. Refer to the *Apple III Standard Device Drivers Manual* for more details.

off-line A device that SOS could communicate with but presently cannot is said to be off-line. A device is off-line if it is not connected to the Apple III or if it is connected and not turned on. A disk drive, for example, is off-line if it has no disk in it, or if the door is open.

operating system A program that supplies mediating services between computer hardware and a user or users' program. The operating system of the Apple III is called SOS (which see).

pathname The full name by which SOS identifies a file. A pathname is a sequence of local names, each preceded by a slash, that specify the path you take from directory to directory to get to a certain file. A pathname always begins with a volume name and ends with the local name of a file. The pathname /ACCOUNTING/PAYABLE/QUIGLY identifies QUIGLY as a file on the volume (usually a disk) ACCOUNTING, in the directory PAYABLE.

prefix A pathname that specifies all or part of a pathname. You can get at all files within the directory named by the prefix simply by mentioning their local names. For example, if you use the SCP's Prefix command to set the prefix to /ACCOUNTING/PAYABLE you can use the local name QUIGLY to get at /ACCOUNTING/PAYABLE/QUIGLY. Then to specify a file in another directory, for example /ACCOUNTING/RECEIVABLE, you must use either its entire pathname or change the prefix. Device names do not require a prefix.

peripheral Shortened form of peripheral device. A device that is not within the Apple III's case. Synonym: external device.

printer driver The device driver that enables the Apple III's operating system to communicate with a printer.

resolution The size and density of the small dots that form characters and other images on the screen.

root directory The main directory of a volume. The root directory is identified by the name of that volume. For example, the root directory of the disk called ACCOUNTING is /ACCOUNTING .

System Configuration Program See SCP.

SCP The SCP (System Configuration Program) is a program which allows you to add and delete device drivers, change their parameters, and create and organize files.

scroll To move all the information within a window on the monitor screen to create room for the display of additional information. When the cursor is on the bottom line of the monitor screen, and you press RETURN to enter a new line of text, the display scrolls upward one line, and the cursor moves to the head of the new bottom line.

serial interface Electronics in the Apple III that allow the Apple III to send and receive information to any device that understands serial information. Serial information travels through wires one bit at a time.

SOS (pronounced "sauce") The Apple III's Sophisticated Operating System. It provides the means for programs to use the hardware of the Apple III and peripheral devices. A version of SOS is included on every boot disk for the Apple III. You can change (or, configure) SOS, with SCP, to accommodate various devices for use with your Apple III. See operating system.

start up To turn on the Apple III. See initialization (1).

subdirectory A file that contains the local names and locations of other files and that is not the root directory. Every subdirectory has its local name listed in a root directory, or in another subdirectory.

system character set A set of characters of a particular shape and style displayed by the console and graphics drivers including their shape and style. You can change sets with the Standard Character Set Option of the System Parameters display of SCP.

system configuration See configuration.

system parameters Special information that is stored on every boot disk, such as the number of disk drives that the system is configured to use. System parameters can be changed using the System Configuration Program on the Utilities disk.

text Printed information that a person types or will read.

text mode The size and format of the text screen.

type-ahead A feature by which the Apple III remembers all of the keys you press, even if it is busy doing something else (such as writing to a disk). If the Apple III is busy the characters you press may not immediately appear on the monitor screen, but they will not be ignored.

turnkey diskettes Diskettes that execute a specific program when booted. For example, the Demonstration disk that comes with the Apple III is a turnkey diskette.

volume A general term referring to a mass storage device. The volume most commonly used with the Apple III is the diskette. A volume has a name, a root directory with the same name, and its information is organized into files. Each volume the Apple III is using at one time must have a different volume name.

volume name The name of a volume, usually a disk. This name is also the local name of the main, or root, directory of the volume.

wildcard When specifying pathnames to the Filer or SCP, you can use the character = (equal sign) to represent common characters shared by several file names. The equal sign thus used is called the wildcard character.

wraparound The feature that causes the cursor to automatically jump to the beginning of the next line whenever it reaches the right edge of the screen, .

Index

A

- A/D error message 113
- access slots 137
- ACIA error message 113
- additional disk drives 53
- adjusting video monitor 7
- ALPHA LOCK key 19, 56, 99
- angle brackets 17
- Apple II Emulation 137 ff.
- Applesoft 138
- arrow keys 78, 99
- ASCII characters 99
- attaching devices 27, 101
- audio
 - output specifications 135
 - port 105
 - driver 49
- automatic repeat 25

B

- backing up diskettes 42
- backslash 17
- backspace key 20
- bad block 90
- BASIC
 - in Apple II Emulation 137 ff.
 - line editing 22
 - program files 71
- black-and-white video port 105
- blank diskettes 57, 60
- block devices 28
- boot diskettes 12, 48
- booting
 - Emulation diskette 138
 - system 11
- bootstrap 11

- braces 17
- bracket 17
- built-in disk drive 4
- bumps on keys 17

C

- canceling copy operation 46
- canceling lines 21
- card guides 109
- cards, peripheral
 - interface 101, 107 ff.
- care of
 - diskettes 100, 124 ff.
 - Apple III 102, 123 ff.
- carpets 102
- case
 - of Apple III 102
 - (upper/lower) conversion 31
- catalog files (see directories)
- central processor 152
- cents sign 17
- Change System Parameters 52
- character
 - devices 28
 - set 15
- characters 15, 17
- circumflex 17
- clock speed 152
- Closed-Apple key 21, 99
- color video port 104, 132
- Configuration menu 50
- configuring boot diskettes 48 ff.
- configuring the operating system
 - 41, 48 ff.

- connecting
 - additional disk drives 53
 - peripherals 101
 - video monitor 2, 3
 - connector
 - disk drive 103
 - power 103
 - connectors on back panel 103
 - console
 - demonstration 15, 25
 - device 14
 - driver 49, 73
 - specifications 151
 - control characters 21
 - CONTROL key 12, 21, 99
 - CONTROL-RETURN 96
 - CONTROL-X 21, 23
 - copy errors 117 ff.
 - Copy-files command 66, 73
 - Copy-volume command 42, 85, 87
 - copying
 - diskettes 45, 85-87
 - volumes 45, 85-87
 - one-drive 46
 - two-drive 45
 - files 65, 73-76, 82-83
 - correcting errors 20-23, 45, 79, 93-94
 - cover
 - attachment screws 107
 - removal 106-107
 - replacement 112
 - cursor 19
 - cycle time 152
- D**
- daisy chain 10, 103
 - default 45, 78, 92
 - Delete-files comand 67, 76
 - deleting characters 79
 - demonstration
 - diskette 7 ff.
 - menu 8
 - destination volume 45, 86
 - destroying
 - volumes 46
 - information 46
 - destructive backspace 20, 22
 - device
 - drivers 12, 49, 101
 - names 29
 - file 30
 - Device Menu 43, 84
 - devices 27
 - operations on 41, 84
 - diagnostic
 - checks 113
 - messages 113
 - DIAGNOSTIC message 7, 113
 - dimensions, Apple III 152
 - directories 31, 64, 72
 - volume 31, 82-83
 - directory example 64-69
 - disk drive
 - connector 103
 - door 5
 - names 29
 - installation 9, 53, 101 ff.
 - disk-switch message 56
 - diskette
 - care 3, 124-126
 - copying 45, 85-87
 - duplication errors 87, 90-91
 - image 82
 - insertion 4-5
 - label 5, 124
 - life 126
 - request, SOS 56
 - storage 124-126

diskettes
 backup 42
 boot 12
 formatting new 57, 61
 display, video (see video display)
 Down-arrow 97
 driver file
 reading errors 50, 116
 use of 51
 dummy cards 108
 duplicate volume names 55, 59

E

echoing 15
 edge, right 23
 editing feature summary 96
 editing input 93
 electrical specifications 127 ff.
 Emulator, Apple II 137
 ENTER key 18, 97, 99
 entering
 information 16 ff.
 into fields 93-94
 numerical information 17
 equal sign (=) 97
 erasing mistakes
 20-23, 45, 79, 93-94
 error messages 113
 ESCAPE key 96, 99
 extension cords 2
 external devices, installing 101 ff.

F

field editing 78, 93
 fields 58
 File Menu 63
 file
 names 31 ff., 72 ff.
 patterns 74, 94
 handling commands 63
 Filer 63 ff.

filer errors 117
 files, 30, 38
 operations on, 41, 69
 fins, aluminum 102
 FLOPPY DISKS 101
 Format-volume command 57
 61, 88
 formatting
 errors 117 ff.
 new diskettes 42, 57 ff.
 front, Apple III 99

G

general errors 121
 generating new system 53
 graphics
 modes 151, 153
 driver 49
 specifications 151
 grave accent 17

H

handling
 diskettes 3, 124
 peripheral cards 101
 hands on 11
 hard disk instalation 104
 hardware specifications 152
 heat dissipation 102
 high-speed repeat 25
 highlighting 58
 home keys 17

I

I/O ERROR message
 image, diskette or volume 82
 initialization
 of diskettes (see formatting)
 of Apple III (see startup)
 input field editing 93-94
 input/output devices 27, 48, 63

- inserting diskettes 4
- installing
 - printer 49
 - disk drives 9, 53
 - peripheral devices 101 ff.
- interface
 - cards 107 ff.
 - serial 105
- internal disk drive 4
- interpreter 13
- invalid system configuration 54

J

- joysticks 104, 128 ff.

K

- Kernel, SOS
- keyboard
 - description 16, 99
 - specifications 153
- keystrokes

L

- labels, diskette 124
- language 13
- leaving demonstration 25
- Left-arrow key
 - (backspace) 20, 96, 97
- limitations of Apple III Emulation
- List-devices command 91
- List-files command 70
- loading operating system 12
- local names 31
- lowercase letters 31

M

- machine language 27
- machine, the 99
- Main Menu 63

- Make-subdirectory command 64-65, 79
- mass storage 39, 69, 104
- memory specifications 153
- menu
 - selection 93
 - Configuration 50
 - Demonstration 15
 - Device 43, 58
 - File 63
 - Main 41, 58
- microprocessor 152
- mistakes 20-23, 45, 79, 93-94
- Monitor III 7
- monitor, Sanyo 7
- monitor, video (see video monitor)
- mounting the Apple III 111

N

- new diskettes, formatting 57, 61
- noise (of disk drive) 100
- nondestructive backspace 20
- number of disk drives 53
- numeric keypad 17, 100

O

- one, character and key 18
- Open-Apple key 21, 99
- Open-Apple-I 96
- Open-Apple-Left-arrow 96
- Open-Apple-Right-arrow 96
- operating system 12
 - specifications 147
- overstriking 20

P

- packing lists 1
- partial pathnames 37
- Pascal language 141
 - summary 97

- pathnames 32, 35
 - and prefix 37
 - duplicate 78, 80
 - partial 37
 - selection 77, 94
- period (.)
 - in device names 29
 - in local names 31
- peripheral
 - connectors 108
 - cards 107-110
 - devices (see external devices)
 - slots 102
- /PERSONNEL diskette 64
- physical specifications 152
- plugging in 1
- plus-or-minus sign 17
- port(s) 101 ff., 132 ff.
- power
 - connector 103
 - cord and plug 1, 2
 - supply 112
 - switch 6, 102
- prefix 37, 81
- printer
 - driver 49
 - port, Silentype 104
 - specifications
 - installation 49, 101
 - use of 73
- processor 152
- programming languages (see languages)
- protecting information 44, 80, 125

Q

- Qume printers 101

R

- raspy noise (of disk drive) 100
- reading
 - directory 64
 - driver files 50
- recording information 4
- red light (disk drive) 6, 100
- removing
 - diskettes 5
 - peripheral cards 109-110
 - cover 106-107
- Rename-files command 77
- Rename-volume command 88
- repeating keys 25
- replacing cover 112
- RESET button 12
- RETRY message 7
- RETURN key 24, 96, 97, 99
- retype key 20
- RGB monitor 132
- Right-arrow key (retype key)
 - 20, 96, 97
- ROM memory 153
- RS-232-C
 - interface 101, 131
 - driver 49
- rugs 102

S

- Sanyo monitor 7
- SCP errors 116
- SCP (see System Configuration Program)
- screen
 - edge 23
 - specifications
- scrolling 23, 24
- security mount 111
- serial
 - I/O specifications 152
 - interface port 105

- set-Prefix command 37, 81
 - set-Time command 92
 - set-Write-protection command 80
 - setting
 - date 92
 - time 92
 - Shakespeare 20
 - SHIFT keys 18, 21, 99
 - Silentype
 - printer port 104
 - driver 49
 - use of 73
 - silver tabs 125
 - size, Apple III 152
 - slash (/)
 - in pathnames 32
 - through zero 18
 - slots, peripheral (see peripheral)
 - Sophisticated Operating System (see SOS)
 - SOS 27
 - errors 114
 - Kernel 115
 - message system 56
 - specifications 147
 - SOS.DRIVER file 52-55, 115
 - SOS.INTERP file 115
 - SOS.KERNEL file 115
 - source volume 45, 86
 - speaker 111
 - special keys 18
 - specifications
 - operating system 147
 - hardware 152
 - standard device drivers 49
 - starting up 6
 - startup
 - errors 113
 - routines 11
 - subdirectories 32, 37, 64
 - swapping diskettes 47-48, 56-57
 - System Configuration Program 28, 48 ff.
 - system
 - generation errors 116
 - parameter-editing errors 116
 - parameters 52
 - SYSTEM FAILURE error
 - message 121
- T**
- TAB key 99
 - temperature 125, 153
 - text modes 151, 153
 - tilde 17
 - transporting Apple III
 - turning power off 8
 - turnkey systems 13
 - type-ahead demonstration 25
 - types, file 71
 - typing on the keyboard 17 ff.
 - typographical errors 20-23
- U**
- unpacking 1
 - up-arrow key 97
 - updating SOS
 - uppercase letters 31
 - using
 - devices 27
 - files 38-39
 - Utilities diskette 28, 41 ff., 63, 93
 - Main Menu 93
- V**
- VADER, destruction of 87, 89
 - validation 54
 - Verify-volume command 90
 - vertical bar 17

- video
 - cable 2, 3
 - monitor
 - adjusting 7
 - connecting 2, 3
 - output specifications 154
 - port
 - black-and-white 135
 - color 132-134
- volatile memory 9
- volume(s) 57
 - and devices 84
 - copying 85
 - image 82
 - names 55, 57, 59
 - random names 89

W

- weight, Apple III
- Widget example 33
- wildcards 74-75, 96
- wrapping 23
- write-protecting
 - diskettes 125
 - files 44, 80
 - volumes 44
 - error 80

X**Y****Z**

- zero (vs. 0) 18



Apple II

Owner's Guide

Tuck end-flap
inside back cover
when using manual.



 **apple computer**

10260 Bandley Drive
Cupertino, California 95014
(408) 950-1010

030-0121-B

